

JVC



DVD DIGITAL CINEMA SYSTEM

TH-A35

Consists of XV-THA35 and SP-THA35

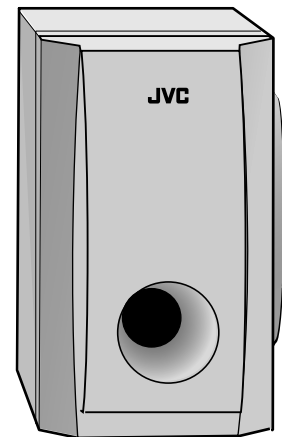
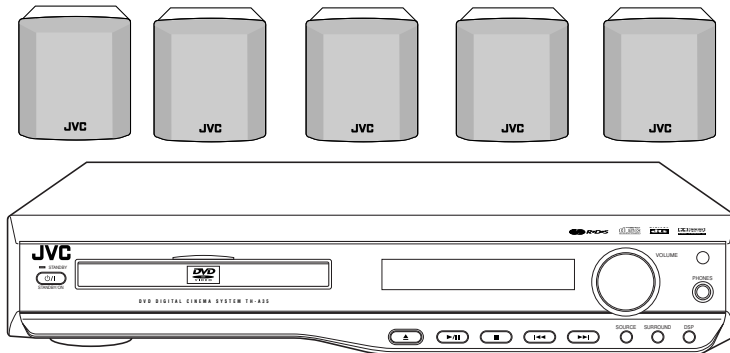
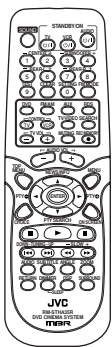

INSTRUCTIONS

For Customer Use:

Enter below the Model No. and Serial No. which are located either on the rear, bottom or side of the cabinet. Retain this information for future reference.

Model No. _____

Serial No. _____

LVT1009-003D

[B]

Warnings, Cautions and Others

IMPORTANT for the U.K.

DO NOT cut off the mains plug from this equipment. If the plug fitted is not suitable for the power points in your home or the cable is too short to reach a power point, then obtain an appropriate safety approved extension lead or consult your dealer.

BE SURE to replace the fuse only with an identical approved type, as originally fitted.

If nonetheless the mains plug is cut off ensure to remove the fuse and dispose of the plug immediately, to avoid a possible shock hazard by inadvertent connection to the mains supply.

If this product is not supplied fitted with a mains plug then follow the instructions given below:

IMPORTANT.

DO NOT make any connection to the terminal which is marked with the letter E or by the safety earth symbol or coloured green or green-and-yellow.

The wires in the mains lead on this product are coloured in accordance with the following code:

Blue : Neutral
Brown : Live

As these colours may not correspond with the coloured markings identifying the terminals in your plug proceed as follows:

The wire which is coloured blue must be connected to the terminal which is marked with the letter N or coloured black.

The wire which is coloured brown must be connected to the terminal which is marked with the letter L or coloured red.

IF IN DOUBT - CONSULT A COMPETENT ELECTRICIAN.

CAUTION

To reduce the risk of electrical shocks, fire, etc.:

1. Do not remove screws, covers or cabinet.
2. Do not expose this appliance to rain or moisture.

Caution —STANDBY/ON \odot /I switch!

Disconnect the mains plug to shut the power off completely.

The STANDBY/ON \odot /I button in any position does not disconnect the mains line.

The power can be remote controlled.

CAUTION

- Do not block the ventilation openings or holes.
(If the ventilation openings or holes are blocked by a newspaper or cloth, etc., the heat may not be able to get out.)
- Do not place any naked flame sources, such as lighted candles, on the apparatus.
- When discarding batteries, environmental problems must be considered and local rules or laws governing the disposal of these batteries must be followed strictly.
- Do not expose this apparatus to rain, moisture, dripping or splashing and that no objects filled with liquids, such as vases, shall be placed on the apparatus.

IMPORTANT FOR LASER PRODUCTS

REPRODUCTION OF LABELS

① CLASSIFICATION LABEL, PLACED ON REAR ENCLOSURE

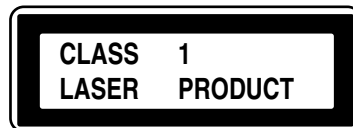

② WARNING LABEL, PLACED INSIDE THE UNIT

CAUTION : Visible and invisible laser radiation when open and interlock failed or defeated. AVOID DIRECT EXPOSURE TO BEAM. (e)	ADVARSEL : Synlig og usynlig laserstråling når maskinen er åben eller interlocken fejler. Undgå direkte eksponering til stråling. (d)
WARNING : Synlig och osynlig laserstråling när den öppnas och spärren är urkopplad. Betrakta ej strålen. (s)	VARO : Avattaessa ja suojalukitus ohitettuna tai viallisena olet alttiina näkyvälle ja näkymättömälle lasersäteilylle. Vältä säteiden kohdistumista suoraan itseesi. (f)

1. CLASS 1 LASER PRODUCT
2. **CAUTION**: Visible and invisible laser radiation when open and interlock failed or defeated. Avoid direct exposure to beam.
3. **CAUTION**: Do not open the top cover. There are no user serviceable parts inside the Unit; leave all servicing to qualified service personnel.

Caution: Proper Ventilation

To avoid risk of electric shock and fire and to protect from damage.

Locate the apparatus as follows:

- Front: No obstructions open spacing.
- Sides: No obstructions in 10 cm from the sides.
- Top: No obstructions in 10 cm from the top.
- Back: No obstructions in 15 cm from the back
- Bottom: No obstructions, place on the level surface.

In addition, maintain the best possible air circulation as illustrated.

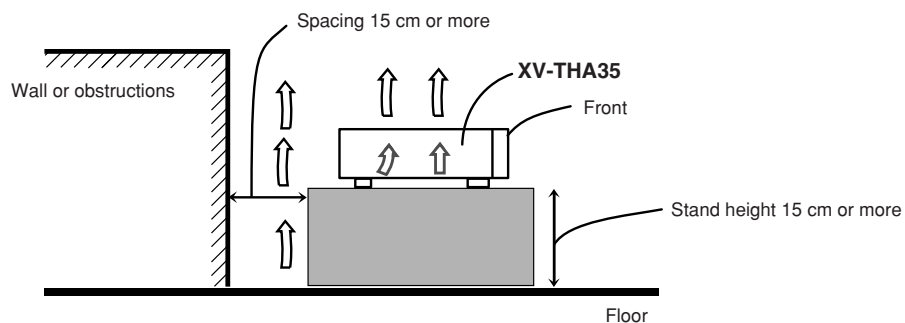

SAFETY INSTRUCTIONS

“SOME DOS AND DON'TS ON THE SAFE USE OF EQUIPMENT”

This equipment has been designed and manufactured to meet international safety standards but, like any electrical equipment, care must be taken if you are to obtain the best results and safety is to be assured.

Do read the operating instructions before you attempt to use the equipment.

Do ensure that all electrical connections (including the mains plug, extension leads and interconnections between pieces of equipment) are properly made and in accordance with the manufacturer's instructions. Switch off and withdraw the mains plug when making or changing connections.

Do consult your dealer if you are ever in doubt about the installation, operation or safety of your equipment.

Do be careful with glass panels or doors on equipment.

DON'T continue to operate the equipment if you are in any doubt about it working normally, or if it is damaged in any way—switch off, withdraw the mains plug and consult your dealer.

DON'T remove any fixed cover as this may expose dangerous voltages.

DON'T leave equipment switched on when it is unattended unless it is specifically stated that it is designed for unattended operation or has a standby mode.

Switch off using the switch on the equipment and make sure that your family know how to do this.

Special arrangements may need to be made for infirm or handicapped people.

DON'T use equipment such as personal stereos or radios so that you are distracted from the requirements of traffic safety. It is illegal to watch television whilst driving.

DON'T listen to headphones at high volume as such use can permanently damage your hearing.

DON'T obstruct the ventilation of the equipment, for example with curtains or soft furnishings.

Overheating will cause damage and shorten the life of the equipment.

DON'T use makeshift stands and NEVER fix legs with wood screws — to ensure complete safety always fit the manufacturer's approved stand or legs with the fixings provided according to the instructions.

DON'T allow electrical equipment to be exposed to rain or moisture.

ABOVE ALL

— NEVER let anyone, especially children, push anything into holes, slots or any other opening in the case —this could result in a fatal electrical shock.;

— NEVER guess or take chances with electrical equipment of any kind — it is better to be safe than sorry!

Table of Contents

Parts Identification	2	Repeating Playback	27
Center Unit	2	■ Repeat Play	27
Remote Control	3	■ A–B Repeat	27
Getting Started	4	Playing Back Chapters in Random Order—Shuffle Play	28
Before Installation	4	Programming the Playing Order of the Chapters	
Checking the Supplied Accessories	4	—Program Play	29
Putting Batteries in the Remote Control	4	DVD Special Effect Playback	30
Connecting the FM and AM Antennas	5	■ Still Picture/Frame-by-Frame Playback	30
Speaker Layout Diagram	6	■ Slow Motion Playback	31
Connecting the Speakers	7	■ Zoom	31
Connecting Audio/Video Component	8	VCD/CD Playback	32
Basic DVD Operations	10	Showing the On-Screen Menu	32
1 Turn On the Power	10	Showing the Information on the TV Screen	32
2 Select the Source	10	Disc Menu-Driven Playback (Only for VCD)	33
3 Load a DVD	10	Selecting Playback Channel	33
4 Start Playback	10	Moving to a Particular Portion Directly	33
5 Adjust the Volume	10	Searching for a Particular Point	34
6 Activate Surround or DSP Mode	11	Repeating Playback	34
7 Stop Playback	11	■ Repeat Play	34
Basic VCD/CD Operations	12	■ A–B Repeat	35
1 Turn On the Power	12	Playing Back Tracks in Random Order—Shuffle Play	35
2 Select the Source	12	Programming the Playing Order of the Tracks	
3 Load a VCD/CD	12	—Program Play	36
4 Start Playback	12	VCD Special Effect Playback	37
5 Adjust the Volume	12	■ Still Picture/Frame-by-Frame Playback	37
6 Activate Surround or DSP Mode	13	■ Slow Motion Playback	37
7 Stop Playback	13	■ Zoom	37
Basic Tuner Operations	14	MP3 Playback	38
1 Turn On the Power	14	Starting Playback	39
2 Select the Band	14	Operations Using the On-Screen Display	40
3 Adjust the Volume	14	Moving to a Particular Track Directly	40
4 Tune into a Station	14	Programming the Playing Order of the Tracks	
5 Activate Surround or DSP Mode	15	—Program Play	40
Other Basic Operations	16	JPEG Playback	42
Enjoying Sounds from the External Component	16	Loading the Disc	42
Listening with the Headphones	17	Operations Using the On-Screen Display	43
Adjusting the Brightness	17	Moving to a Particular File Directly	44
Turning Off the Power with the Timer	18	Programming the Playing Order of the Files	
Adjusting the Pictures	18	—Program Play	44
Creating Realistic Sound Fields	19	Tuner Operations	46
■ Dolby Surround	19	Tuning in Stations	46
■ Dolby Digital	19	Using Preset Tuning	47
■ DTS Digital Surround	19	Selecting the FM Reception Mode	47
■ DSP (Digital Signal Processor) Modes	20	Using the RDS (Radio Data System)	
Activating the Surround Mode	20	to Receive FM Stations	48
Adjusting the Sound	21	Searching for a Program by PTY Codes	49
Disc Introduction—DVD/VCD/CD	22	Switching to a Selected Program	50
Basic Disc Operations	23	■ Description of the PTY codes	51
DVD Playback	24	Setting up the DVD Preferences	52
Showing the On-Screen Menu	24	Using the Choice Menus	52
Showing the Information on the TV Screen	24	Language Menu	53
Selecting the Subtitles	25	Picture Menu	54
Selecting the Audio Languages	25	Audio Menu	55
Selecting the Multi-Angle Views	25	Setting Menu	55
Disc Menu-Driven Playback	26	Setting the Parental (Rating) Level	57
Moving to a Particular Portion Directly	26	Operating JVC's Components	58
Searching for a Particular Point	27	Operating Other Manufacturers' TV	59
		Maintenance	60
		Troubleshooting	61
		Specifications	62

Parts Identification

Center Unit

Front Panel

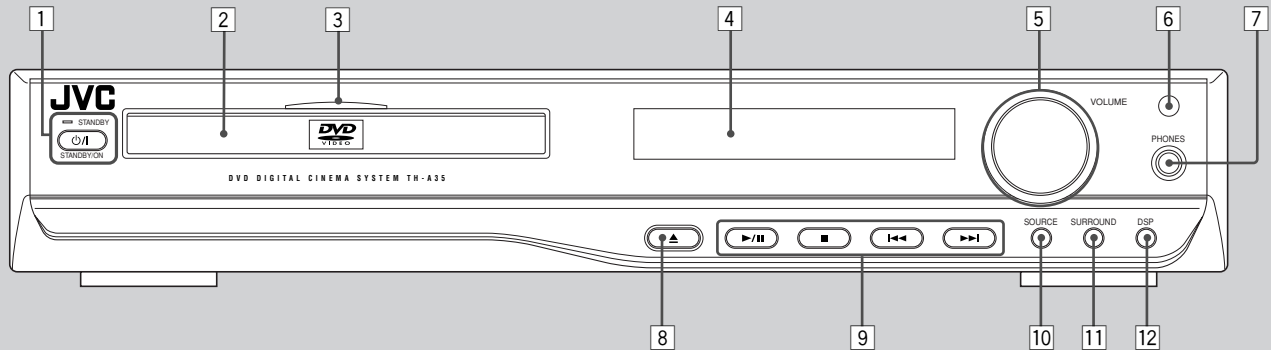

See pages in the parentheses for details.

Front Panel

- | | |
|--|--|
| <ul style="list-style-type: none"> 1 STANDBY/ON \odot/I button and STANDBY lamp (10 – 15) 2 Disc tray (10, 12) 3 Illumination lamp 4 Display window 5 VOLUME control (10, 12, 14) 6 Remote sensor 7 PHONES jack (17) 8 \blacktriangle (open/close) button (10 – 13, 23, 39) <ul style="list-style-type: none"> • Pressing this button also turns on the power and changes the source to the DVD player. | <ul style="list-style-type: none"> 9 $\blacktriangleright/\text{II}$, \blacksquare, \blacktriangleleft, and $\blacktriangleright\blacktriangleright$ buttons <ul style="list-style-type: none"> • Pressing $\blacktriangleright/\text{II}$ also turns on the power and changes the source to the DVD player. 10 SOURCE button (10, 12, 14, 16, 46) 11 SURROUND button (11, 13, 15, 17, 20) 12 DSP button (11, 13, 15, 17, 20) |
|--|--|

Display Window

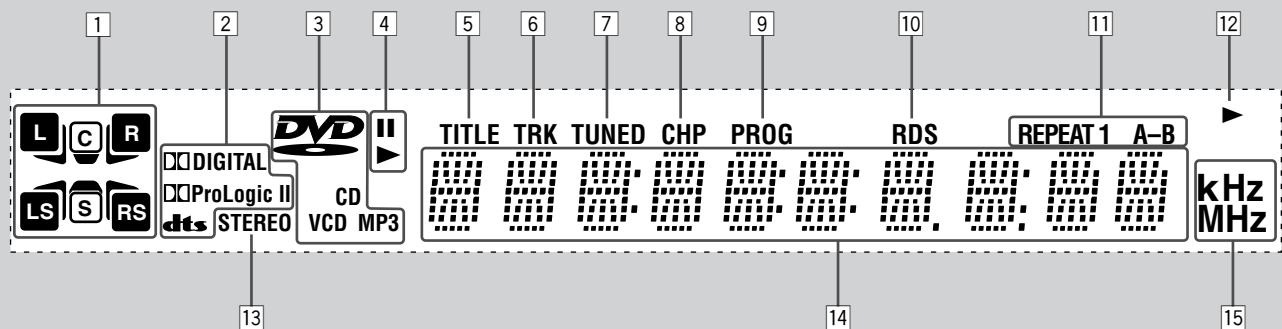

See pages in the parentheses for details.

Display Window

- | | |
|---|---|
| <ul style="list-style-type: none"> 1 Audio channel indicators <ul style="list-style-type: none"> • Indicates audio channels currently source signal. 2 Sound signal indicators (19, 20) <ul style="list-style-type: none"> • $\square\square$ DIGITAL, $\square\square$ PRO LOGIC II, and DTS 3 Disc indicators (23) <ul style="list-style-type: none"> • DVD, CD, VCD, and MP3 4 Playback indicators <ul style="list-style-type: none"> • \blacktriangleright (play) and II (pause) 5 TITLE indicator (23) 6 TRK (track) indicator (23) | <ul style="list-style-type: none"> 7 TUNED indicator (14, 46) 8 CHP (chapter) indicator (23) 9 PROG (program) indicator (29, 36) 10 RDS indicator (48) 11 Repeat mode indicators (27, 28, 34, 35) <ul style="list-style-type: none"> • REPEAT, 1, and A-B 12 Sleep indicator (18) 13 STEREO indicator (47) 14 Main display 15 Frequency unit indicators <ul style="list-style-type: none"> • MHz (for FM station) and kHz (for AM station) |
|---|---|

Remote Control

Remote Control

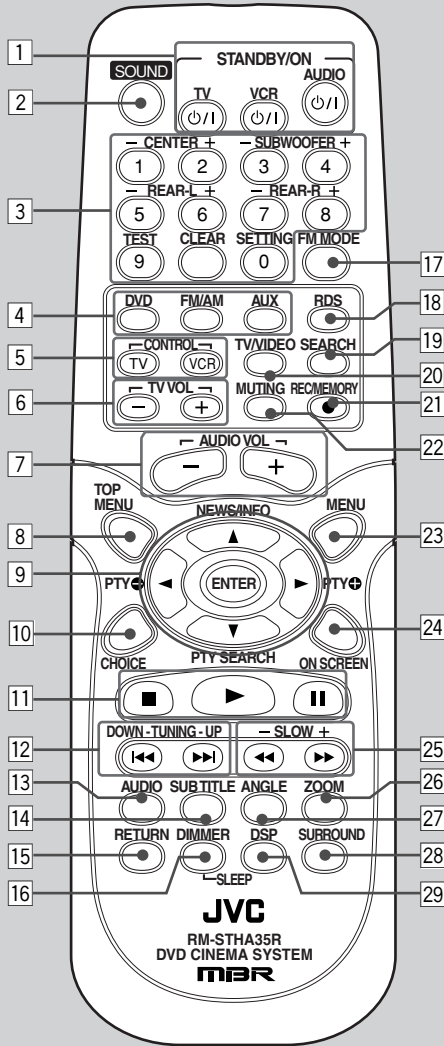

See pages in the parentheses for details.

- 1 STANDBY/ON buttons
 - TV \odot/I button (10, 12, 58, 59)
 - VCR \odot/I button (58)
 - AUDIO \odot/I button (10–15)
- 2 SOUND button (21)
- 3
 - Number buttons (23, 26, 28, 33, 36, 40, 41, 44, 45, 47, 57–59)
 - CLEAR button (26, 30, 33, 37, 54)
 - Sound setting buttons (21)
 - CENTER + and – buttons
 - SUBWOOFER + and – buttons
 - REAR-L + and – buttons
 - REAR-R + and – buttons
 - TEST button
 - SETTING button
- 4 Source selecting buttons (10, 12, 14, 16, 21, 46, 47)
 - DVD, FM/AM, AUX
 - *Pressing one of these buttons also turns on the power.*
- 5 CONTROL buttons
 - TV CONTROL button (58, 59)
 - VCR CONTROL button (58)
- 6 TV VOL + and – buttons (58, 59)
- 7 AUDIO VOL + and – buttons (10, 12, 14, 16)
- 8 TOP MENU button (26)
- 9 Menu operation buttons
 - cursor \blacktriangleright , \blacktriangleleft , \blacktriangleup , and \blacktriangledown buttons
 - NEWS/INFO button
 - PTY \oplus and \ominus buttons
 - PTY SEARCH button
 - ENTER button
- 10 CHOICE button (18, 52–57)
- 11 \blacksquare , \blacktriangleright , and II buttons
- 12 $\text{I}\lll$ and $\text{I}\ggg$ buttons (23, 33, 39, 41, 43, 45, 58)
- 13 TUNING UP and DOWN buttons (14, 46)
- 14 AUDIO button (25)
- 15 SUB TITLE button (25)
- 16 RETURN button (33)
- 17 DIMMER button (17)
- 18 SLEEP button (18)
- 19 FM MODE button (47)
- 20 RDS button (48)
- 21 SEARCH button (26, 33)
- 22 TV/VIDEO button (58, 59)
- 23 REC/MEMORY button (47, 58)
- 24 MUTING button (11, 13, 14, 16)
- 25 MENU button (26, 33)
- 26 ON SCREEN button (24, 27–30, 32, 34–37)
- 27 \lll and \ggg buttons (27, 31, 34, 37, 47, 58, 59)
- 28 SLOW + and – buttons (31, 37)
- 29 ZOOM button (31, 37, 43, 45)
- 30 ANGLE button (25)
- 31 SURROUND button (11, 13, 15, 17, 20)
- 32 DSP button (11, 13, 15, 17, 20)

Getting Started

Before Installation

General Precautions

- DO NOT insert any metal object into the center unit.
- DO NOT disassemble the center unit or remove screws, covers, or cabinet.
- DO NOT expose the center unit to rain or moisture.

Locations

- Install the center unit in a location that is level and protected from moisture.
- The temperature around the center unit must be between 5°C and 35°C (41°F and 95°F).
- Make sure there is good ventilation around the center unit. Poor ventilation could cause overheating and damage the center unit.

Handling the center unit

- DO NOT touch the power cord with wet hands.
- DO NOT pull on the power cord to unplug the cord. When unplugging the cord, always grasp the plug so as not to damage the cord.
- Keep the power cord away from the connecting cords and the antennas. The power cord may cause noise or screen interference. It is recommended to use a coaxial cable for antenna connection, since it is well-shielded against interference.
- When a power failure occurs, or when you unplug the power cord, the preset settings such as preset FM/AM channels and sound adjustments may be erased in a few days.

Checking the Supplied Accessories

Check to be sure you have all of the following supplied accessories. The number in the parentheses indicates the quantity of the pieces supplied.

- **Remote Control (1)**
- **Batteries (2)**
- **AM Loop Antenna (1)**
- **FM Antenna (1)**
- **Video cord (1)**
- **Speaker cords**
 - 6 m (4)*:** For left front speaker, right front speaker, center speaker, and subwoofer
 - 10 m (2)*:** For left rear speaker and right rear speaker

* The lengths of the speaker cords above are approximate.

If anything is missing, contact your dealer immediately.

Putting Batteries in the Remote Control

Before using the remote control, put two supplied batteries first.

- When using the remote control, aim the remote control directly at the remote sensor on the center unit.

1. **On the back of the remote control, remove the battery cover.**

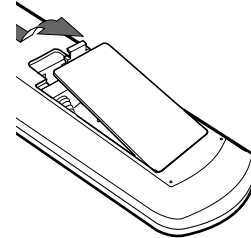

2. **Insert batteries. Make sure to match the polarity: (+) to (+) and (-) to (-).**

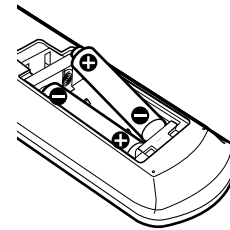

3. **Replace the cover.**

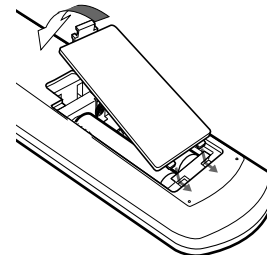

If the range or effectiveness of the remote control decreases, replace the batteries. Use two R6P (SUM-3)/AA(15F) type dry-cell batteries.

CAUTION:

Follow these precautions to avoid leaking or cracking cells:

- Place batteries in the remote control so they match the polarity: (+) to (+) and (-) to (-).
- Use the correct type of batteries. Batteries that look similar may differ in voltage.
- Always replace both batteries at the same time.
- Do not expose batteries to heat or flame.

Connecting the FM and AM Antennas

If AM reception is poor, connect single vinyl-covered wire (not supplied).

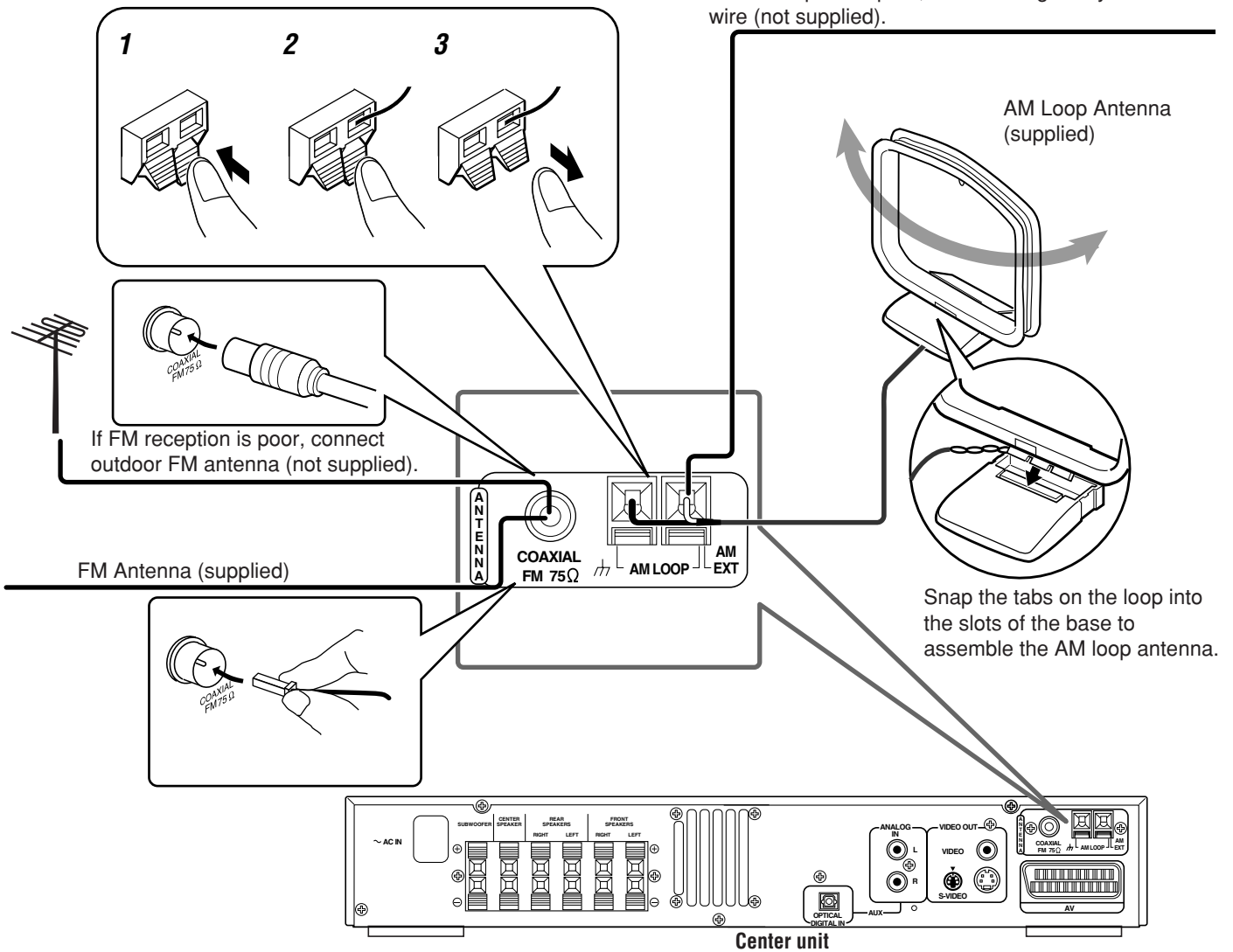

FM antenna connection

Connect the supplied FM antenna to the COAXIAL FM 75 Ω terminal as temporary measure.

Extend the supplied FM antenna horizontally.

- If reception is poor, connect an outdoor antenna (IEC or DIN45325.) Before attaching a 75 Ω coaxial cable (with a standard type connector), disconnect the supplied FM antenna.

AM antenna connection

Connect the supplied AM loop antenna to the AM LOOP terminals. Connect the white cord to the AM EXT terminal, and the black cord to the \hbar terminal.

Turn the loop until you have the best reception.

- If reception is poor, connect an outdoor single vinyl-covered wire to the AM EXT terminal. (Keep the AM loop antenna connected.)

Note:

If the AM loop antenna wire is covered with vinyl, remove the vinyl by twisting it as shown in the diagram.



Getting Started

Speaker Layout Diagram

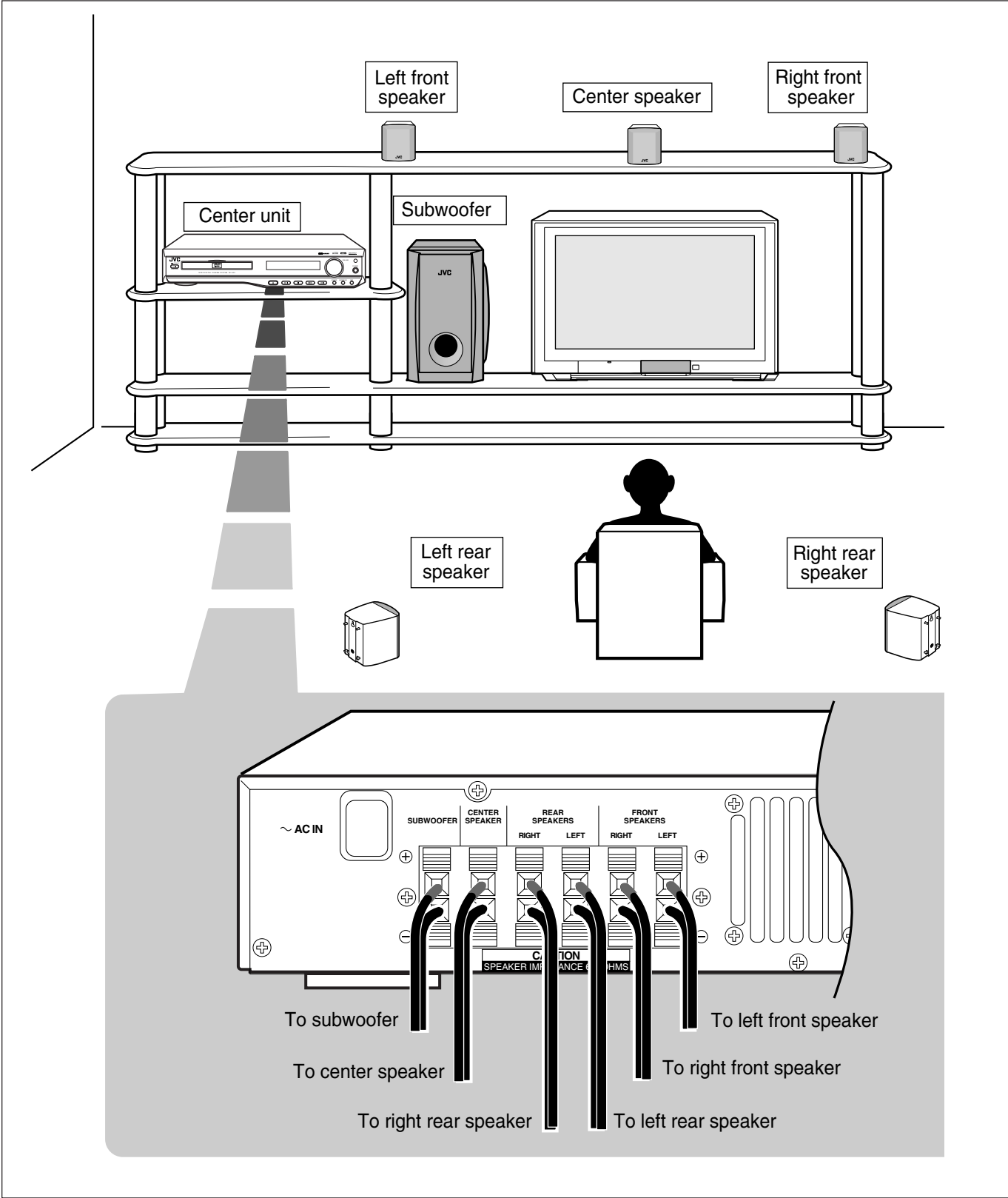

Connecting the Speakers

Connect the satellite speakers and subwoofer to the terminals on the rear panel using speaker cords supplied.

Color labels are attached to the speaker cords to indicate the speaker and the terminal to which each is to be connected.

- The five satellite speakers can be used for any positions—center, front left and right, and rear left and right.
- Connect the color labeled cord to the color (+) terminal, and the other cord to the black (–) terminal respectively.

CAUTION:

Use speakers with the SPEAKER IMPEDANCE indicated by the speaker terminals.

Connecting speaker cords to the terminals

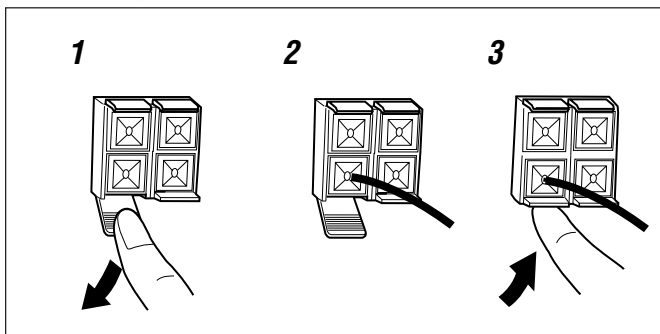

1 Open the terminal clamp.

2 Insert the speaker cord.

3 Close the clamp.

Notes:

- If the speaker cord is covered with vinyl, remove the vinyl by twisting it as shown in the diagram.
- Make sure the core wire of speaker cords do not expose to out of the terminals. This could cause short-circuit.



When setting the speakers

To obtain the best possible sound from this system, you need to place all the speakers except the subwoofer at the same distance from the listening position with each front faced toward the listener. Since bass sound is less-directional, but normally place it in between right and left front speaker shown as below.

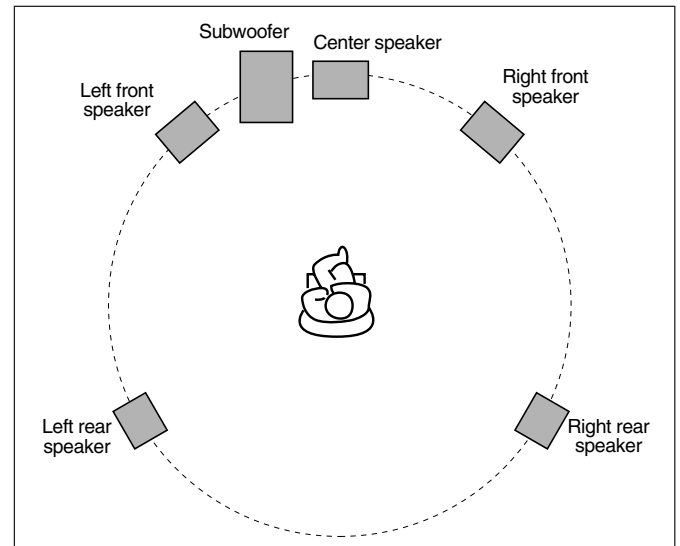

If your speakers cannot be placed at the same distance from the listening position

You can adjust the delay time of the center speaker and rear speakers. For in-depth information about adjusting the delay time, see “Setting Menu” on pages 55 and 56.

Note:

Subwoofer phase is closely related with the distance from the listening position to the front speakers and subwoofer. You can change the phase to obtain better bass sound by connecting the speaker cords to the terminals of the subwoofer inversely—the color labeled cord to the black terminal, and the black cord to the color terminal.

CAUTION:

- When attaching the satellite speakers on the wall, have them attached to the wall by a qualified person.
DO NOT attach the satellite speakers on the wall by yourself to avoid an unexpected damage of their falling from the wall, caused by incorrect attachment or weakness in the wall.
- Care is required in selecting a location for attaching speakers to the wall. Injury to personnel, or damage to equipment, may result if the speakers are attached in a location which interferes with daily activities.

Getting Started

Connecting Audio/Video Component

Turn the power off to all components before connections.

Audio Component connection

Connect the other component to the center unit with the audio cord.
Use the cords supplied with the other component or purchase them at an electric appliance store.

A Optical digital cord (not supplied)

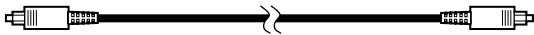

B Audio cord (not supplied)

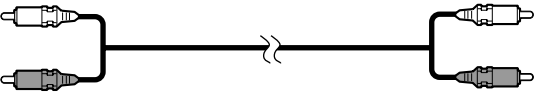

Illustrations of the input/output terminals below are typical examples.
When you connect the other component, refer also to its manuals since the terminal name actually printed on the rear vary among the components.

If you connect a sound-enhancing device such as a graphic equalizer between the source component and the center unit, the sound output through this system may be distorted.

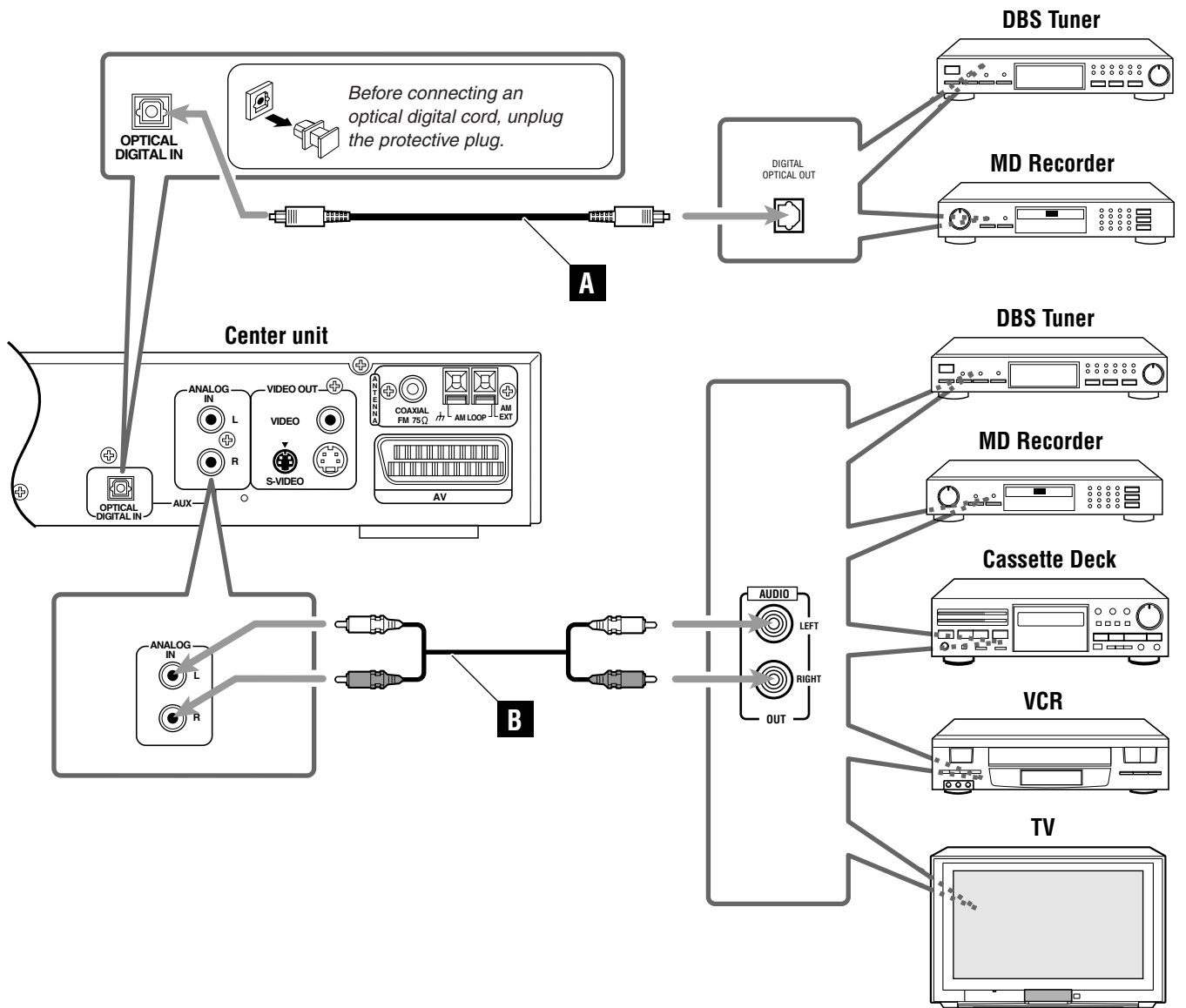

TV connection

The S-video cord and the SCART cable are not supplied with this system.
Use the cords or cables supplied with the other component or purchase them at an electric appliance store.

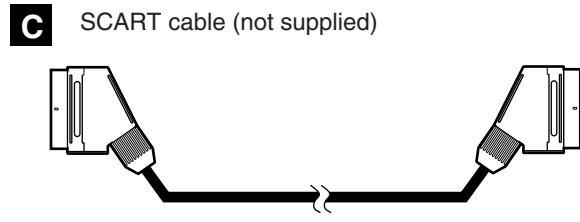
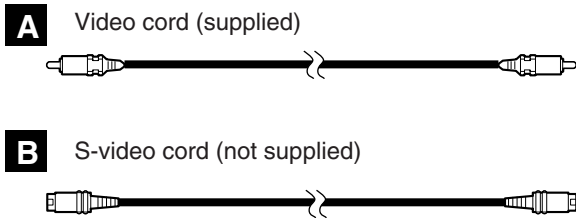

You can select one of three connection types—**A**, **B**, and **C**.

For using the composite video cord or S-video cord

- If your TV has S-video (Y/C-separation) jack, connect it using an S-video cord (not supplied) **B**.
By using this jack, you can get a better picture quality than using composite video cord connection **A**.
- When you use the S-video cord to connect the TV, you select the video signal type correctly. See "Picture Menu" on page 54.

For using the SCART cable (**C**)

If you use the SCART cable to connect the TV, you select the video signal type correctly. See "Picture Menu" on page 54.

- S-video (Y/C-separation) signal does not output from the AV (SCART) connector.
If you want to use S-video (Y/C-separation) signal, connect the TV using an S-video cord (not supplied) **B**.
- If you use the SCART cable to connect the TV, you can enjoy the sound with TV speakers.
When you play back a DVD and select the speaker settings to 2.1 ch (see page 21), the front left and right, center, and rear channel signals are down-mixed and then output from the AV (SCART) connector.
Otherwise, the front left, right channel signals are output from the AV (SCART) connector.

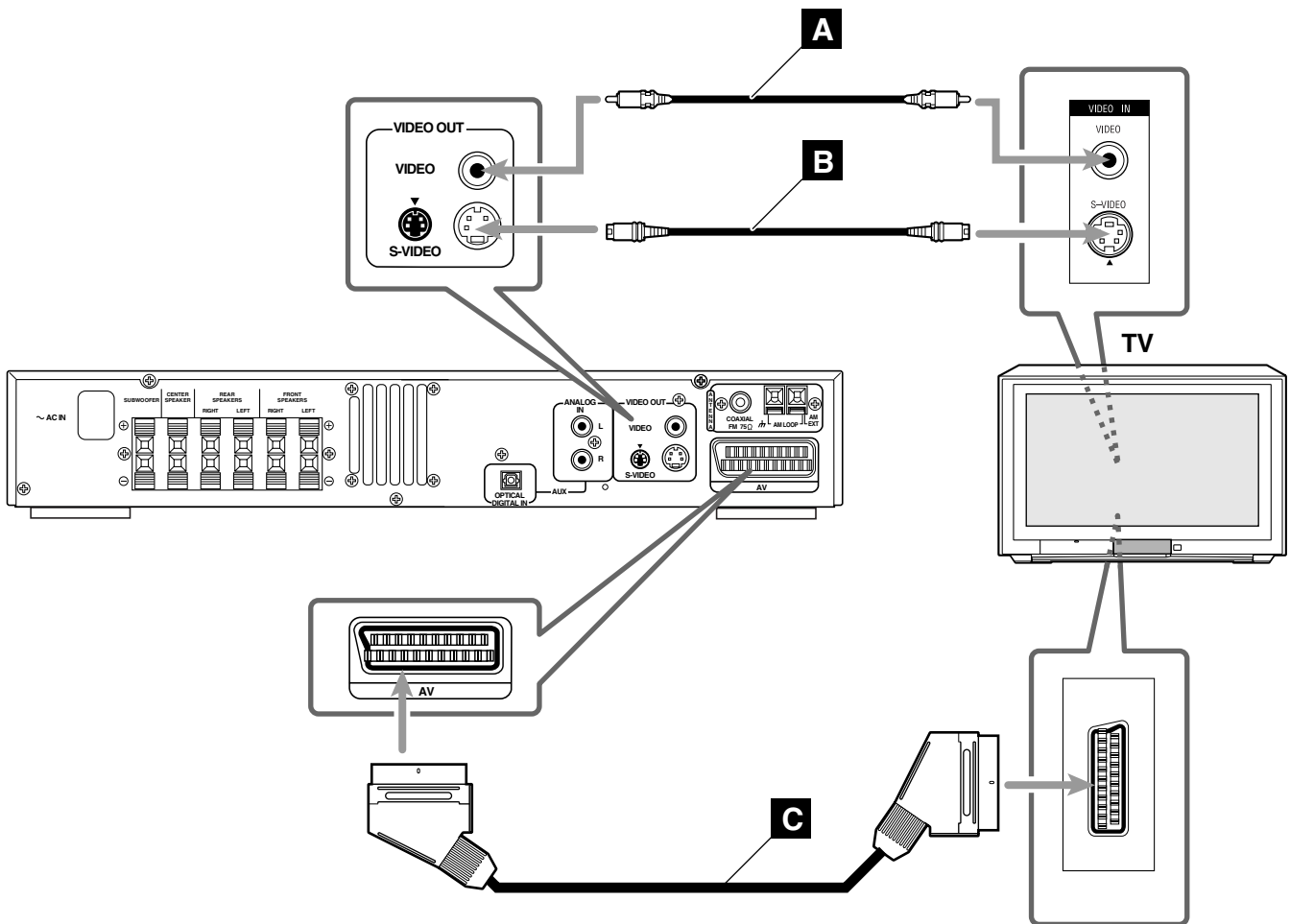

Now, you can plug the power cord of the center unit into the AC outlet.

Notes:

- Keep the power cord away from the connecting cords and the antenna cords. The power cord may cause noise or screen interference.
- Connecting to a TV through a VCR, or to a TV with a built-in VCR, may cause distortion of picture.

Basic DVD Operations

This manual mainly explains operations using the buttons on the remote control. You can also use the buttons on the center unit if they have the similar names (or marks) as those on the remote control.

If operations using the center unit are different from those using the remote control, they are then explained.

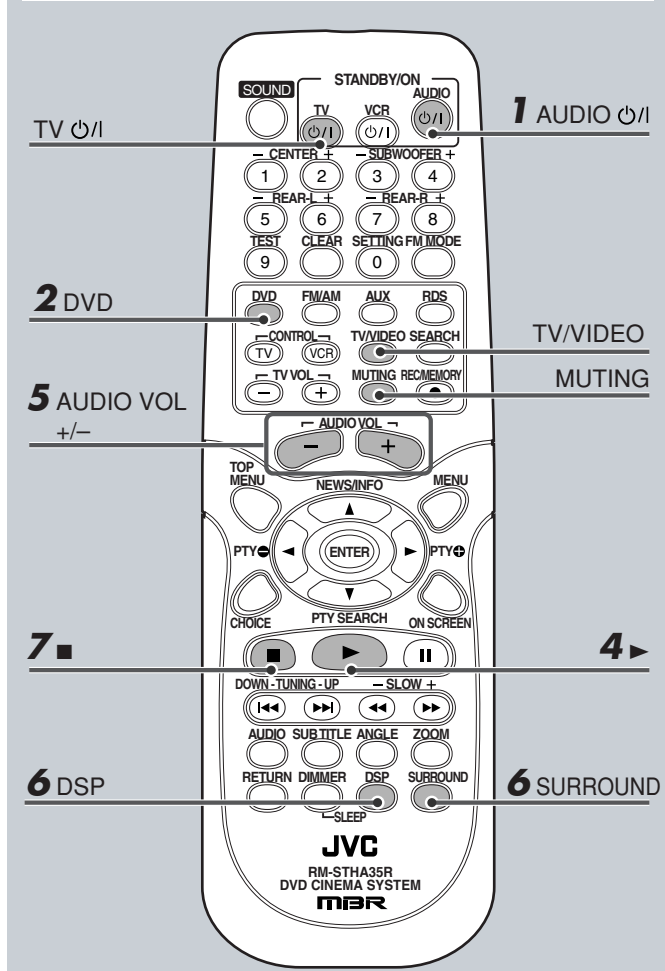

For in-depth information about DVD operations, see pages 22 to 31.

1 Turn On the Power

Before turning on the system, turn on your TV and select the correct video input. (See the manual supplied with your TV.)

- When you use a JVC's TV, you can turn on your TV by pressing TV $\phi/|$ on the remote control, and select the video input by pressing TV/VIDEO. (If your TV is not a JVC's, see "Operating Other Manufacturers' TV" on page 59.)
- For changing the OSD messages—the information on the TV screen—into the desired language, see "Language Menu" on pages 53.

Press AUDIO $\phi/|$ (or $\phi/|$ STANDBY/ON on the front panel).

The STANDBY lamp goes off and the illumination lamp on the center unit lights up. The source indication selected previously appears on the display.



2 Select the Source

Press DVD.

The source changes to DVD.



3 Load a DVD

On the front panel ONLY:

Press \blacktriangle to open the disc tray, then place a DVD correctly with its label side up.

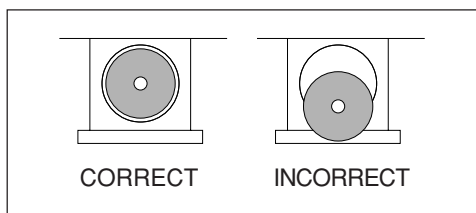

- DO NOT use the disc stabilizer.

4 Start Playback

Press \blacktriangleright .

The disc tray closes. "READING" appears for a while.



- You can also start playback by closing the disc tray using \blacktriangle on the front panel.

5 Adjust the Volume

From the remote control :

To increase the volume, press and hold AUDIO VOL +.

To decrease the volume, press and hold AUDIO VOL -.



On the front panel :

To increase the volume, turn VOLUME control clockwise.

To decrease the volume, turn VOLUME control counterclockwise.

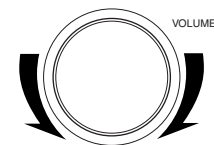

CAUTION:

Always set the volume to the minimum before starting any source. If the volume is set at its high level, the sudden blast of sound energy can permanently damage your hearing and/or ruin your speakers.

Notes:

- By pressing AUDIO VOL + or - repeatedly, you can adjust the volume level step by step.
- The volume level can be adjusted within 64 steps—"MIN (minimum)," 01 to 62, and "MAX (maximum)."
- If you have turned off the unit with the volume level set at more than level "25," the volume level will be automatically set at level "25" next time you turn on the unit.

To turn off the sounds temporarily

From the remote control ONLY:

Press **MUTING**.



To restore the sound, press **MUTING** again.

- Pressing **AUDIO VOL +** or **-** also restores the sound.

6 Activate Surround or DSP Mode

You can enjoy three kinds of surround—Digital Multichannel Surround (Dolby Digital and DTS Digital Surround), Dolby Pro Logic II and DSP modes.

Digital Multichannel Surround—Dolby Digital and DTS Digital Surround

Dolby Digital or DTS Digital Surround takes effect only when you enjoy a disc encoded with its signals.

To activate Dolby Digital or DTS Digital Surround

When a disc encoded with the Dolby Digital or DTS Digital Surround is loaded, the system detects it and starts playing the disc automatically with Multichannel Surround activated.

- For in-depth information about surround modes, see “Creating Realistic Sound Fields” on pages 19 to 21.

Dolby Pro Logic II—Pro Logic II Music and Pro Logic II Movie

To activate Pro Logic II modes

Press **SURROUND**.

The current Pro Logic II mode appears on the display for a while.

- Each time you press the button, Pro Logic II mode changes as follows:

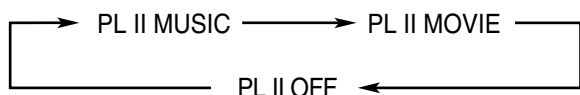

- When Dolby Pro Logic II mode is activated, the **PRO LOGIC II** indicator lights up on the display.

- For in-depth information about Dolby Pro Logic II modes, see “Creating Realistic Sound Fields” on pages 19 to 21.

DSP modes—CONCERT, STADIUM, HALL, THEATER, LIVE HOUSE

To activate DSP modes

Press **DSP**.

The current DSP mode appears on the display for a while.

- Each time you press the button, DSP mode changes as follows:

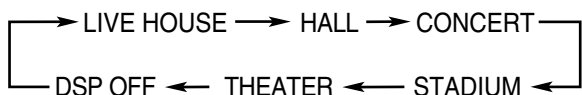

- For in-depth information about DSP modes, see “Creating Realistic Sound Fields” on pages 19 to 21.

Note:

Before activating the Surround or DSP mode, adjust the speaker setting to bring out the best performance from this system. For in-depth information about adjusting the speaker setting, see “Setting Menu” on pages 55 and 56.

7 Stop Playback

Press **■** twice.

Playback stops completely.

- This system can memorize the end point even when you press **■** once. When you start playback again by pressing **▶**, playback begins from where it has been stopped—Resume play.



To remove the loaded disc

Press **▲**.

“OPEN” appears on the display and the disc tray comes out.



To close the disc tray, press **▲** again.

To prohibit disc ejection

On the front panel ONLY:

Press and hold **▶/||** and **◀◀** for more than 3 seconds.

“LOCKED” appears on the display, and the disc tray is locked.



To cancel the prohibition, press and hold **▶/||** and **◀◀** for more than 3 seconds.

“UNLOCK” appears on the display, and the disc tray is unlocked.



To turn off the power (into standby)

Press **AUDIO** (or **○/|** **STANDBY/ON** on the front panel).

The illumination lamp goes off and the **STANDBY** lamp lights up.

- If you press **AUDIO** (or **○/|** **STANDBY/ON** on the front panel) while the disc tray is kept open, the disc tray closes automatically, then the system is turned off.
- A small amount of power is consumed even in standby mode. To turn the power off completely, unplug the AC power cord.



Basic VCD/CD Operations

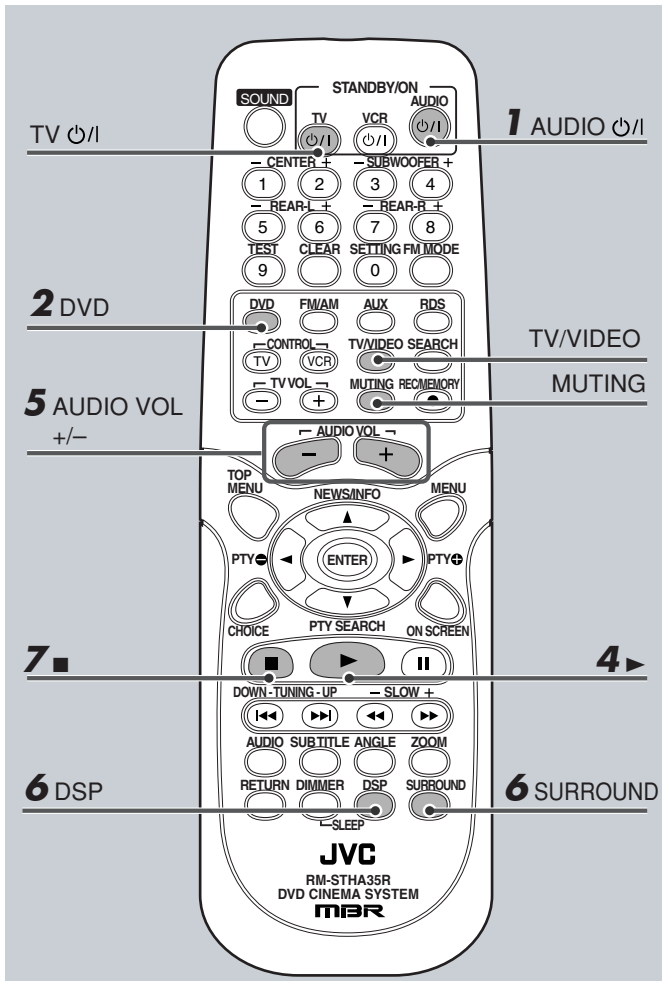

- SVCD can be operated by using the VCD operation procedure.
- For in-depth information about VCD/CD operations, see pages 22, 23, and 32 to 37.

1 Turn On the Power

Before turning on the system, turn on your TV if necessary and select the correct video input. (See the manual supplied with your TV.)

- When you use a JVC's TV, you can turn on your TV by pressing TV $\phi/1$ on the remote control, and select the video input by pressing TV/VIDEO. (If your TV is not a JVC's, see "Operating Other Manufacturers' TV" on page 59.)
- For changing the OSD messages—the information on the TV screen—into the desired language, see "Language Menu" on pages 53.

Press AUDIO $\phi/1$

(or $\phi/1$ /STANDBY/ON on the front panel).

The STANDBY lamp goes off and the illumination lamp on the center unit lights up. The source indication selected previously appears on the display.



2 Select the Source

Press DVD.



3 Load a VCD/CD

On the front panel ONLY:

Press \blacktriangle to open the disc tray, then place a disc correctly with its label side up.

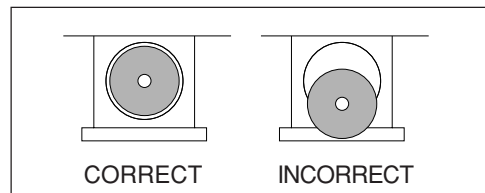

- When using a CD single (8 cm), place it on the inner circle of the disc tray.
- Continued use of irregular shape CDs (heart-shape, octagonal, etc.) can damage the center unit.
- DO NOT use the disc stabilizer.

4 Start Playback

Press \blacktriangleright .

The disc tray closes. "READING" appears for a while.

- You can also start playback by closing the disc tray using \blacktriangle on the front panel.

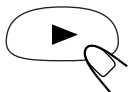

5 Adjust the Volume

From the remote control :

To increase the volume, press and hold AUDIO VOL +.

To decrease the volume, press and hold AUDIO VOL -.



On the front panel :

To increase the volume, turn VOLUME control clockwise.

To decrease the volume, turn VOLUME control counterclockwise.

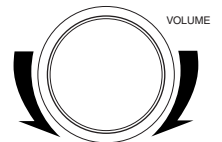

CAUTION:

Always set the volume to the minimum before starting any source. If the volume is set at its high level, the sudden blast of sound energy can permanently damage your hearing and/or ruin your speakers.

Notes:

- By pressing AUDIO VOL + or - repeatedly, you can adjust the volume level step by step.
- The volume level can be adjusted within 64 steps—"MIN (minimum)," 01 to 62 and "MAX (maximum)."
- If you have turned off the unit with the volume level set at more than level "25," the volume level will be automatically set at level "25" next time you turn on the unit.

To turn off the sounds temporarily

From the remote control ONLY:

Press **MUTING**.



To restore the sound, press **MUTING** again.

- Pressing **AUDIO VOL +** or **-** also restores the sound.

6 Activate Surround or DSP Mode

You can enjoy Dolby Pro Logic II mode and DSP modes.

Dolby Pro Logic II—Pro Logic II Movie and Pro Logic II Music

To activate Pro Logic II modes

Press **SURROUND**.

The current Pro Logic II mode appears on the display for a while.



- Each time you press the button, Pro Logic II mode changes as follows:

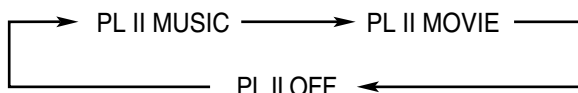

- When Dolby Pro Logic II mode is activated, the **PRO LOGIC II** indicator lights up on the display.

– For in-depth information about Dolby Pro Logic II modes, see “Creating Realistic Sound Fields” on pages 19 to 21.

DSP modes—CONCERT, STADIUM, HALL, THEATER, LIVE HOUSE

To activate DSP modes

Press **DSP**.

The current DSP mode appears on the display for a while.



- Each time you press the button, DSP mode changes as follows:

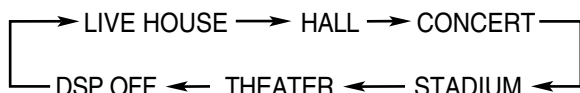

– For in-depth information about DSP modes, see “Creating Realistic Sound Fields” on pages 19 to 21.

Note:

Before activating the Surround or DSP mode, adjust the speaker setting to bring out the best performance from this system.

For in-depth information about adjusting the speaker setting, see “Setting Menu” on pages 55 and 56.

7 Stop Playback

Press **■** twice.

Playback stops completely.

- This system can memorize the end point even when you press **■** once. When you start playback again by pressing **▶**, playback begins from where it has been stopped—Resume play.



To remove the loaded disc

Press **▲**.

“OPEN” appears on the display and the disc tray comes out.



To close the disc tray, press **▲** again.

To prohibit disc ejection

On the front panel ONLY:

Press and hold **▶/||** and **◀◀** for more than 3 seconds.

“LOCKED” appears on the display, and the disc tray is locked.



To cancel the prohibition, press and hold **▶/||** and **◀◀** for more than 3 seconds.

“UNLOCK” appears on the display, and the disc tray is unlocked.



To turn off the power (into standby)

Press **AUDIO** (or

◻/I **STANDBY/ON** on the front panel).



The illumination lamp goes off and the **STANDBY** lamp lights up.

- If you press **AUDIO** (or **◻/I** **STANDBY/ON** on the front panel) while the disc tray is kept open, the disc tray closes automatically, then the system is turned off.
- A small amount of power is consumed even in standby mode. To turn the power off completely, unplug the AC power cord.

Basic Tuner Operations

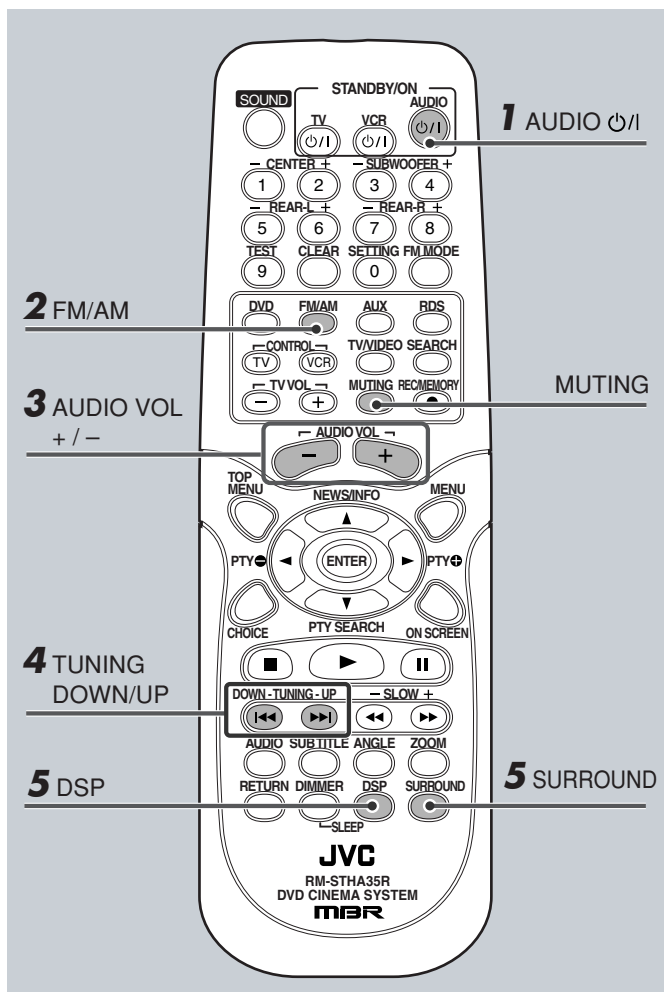

For in-depth information about tuner operations, see "Tuner Operations" on pages 46 to 51.

1 Turn On the Power

Press **AUDIO** (or /STANDBY/ON on the front panel).
The STANDBY lamp goes off and the illumination lamp lights up on the center unit.
The source indication selected previously appears on the display.



2 Select the Band

From the remote control:

Press **FM/AM**.

The last received station of the selected band is tuned into.
• Each time you press the button, the band alternates between FM and AM.



On the front panel:

Press **SOURCE** repeatedly until the desired band (TUNER FM or TUNER AM) appears on the display.



The last received station of the selected band is tuned into.

• Each time you press the button, the source changes as follows:

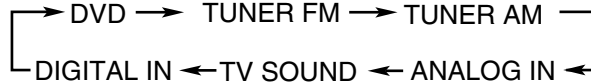

3 Adjust the Volume

From the remote control :

To increase the volume, press and hold **AUDIO VOL +**.
To decrease the volume, press and hold **AUDIO VOL -**.



On the front panel :

To increase the volume, turn **VOLUME** control clockwise.
To decrease the volume, turn **VOLUME** control counterclockwise.



CAUTION:

Always set the volume to the minimum before starting any source. If the volume is set at its high level, the sudden blast of sound energy can permanently damage your hearing and/or ruin your speakers.

Notes:

- By pressing **AUDIO VOL +** or **-** repeatedly, you can adjust the volume level step by step.
- The volume level can be adjusted within 64 steps— "MIN (minimum)," 01 to 62 and "MAX (maximum)."
- If you have turned off the unit with the volume level set at more than level "25," the volume level will be automatically set at level "25" next time you turn on the unit.

To turn off the sounds temporarily

From the remote control ONLY:

Press **MUTING**.



To restore the sound, press **MUTING** again.

• Pressing **AUDIO VOL +** or **-** also restores the sound.

4 Tune into a Station

From the remote control:

Press and hold **TUNING UP** or **DOWN** until the station frequency starts changing continuously on the display.



The system starts searching for a station.

When a station of sufficient signal strength is tuned in, the system stops searching, and the TUNED indicator lights up on the display.

On the front panel:

Press and hold **||<<<** or **>>>||** until the station frequency starts changing continuously on the display.

Notes:

- When an FM stereo program is received, the STEREO indicator also lights up.
- When you press the button repeatedly, the frequency changes step by step.

5 Activate Surround or DSP Mode

You can enjoy Dolby Pro Logic II mode and DSP modes.

Dolby Pro Logic II—Pro Logic II Movie and Pro Logic II Music

To activate Pro Logic II modes

Press **SURROUND**.

The current Pro Logic II mode appears on the display for a while.



- Each time you press the button, Pro Logic II mode changes as follows:

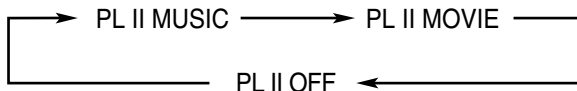

- When Dolby Pro Logic II mode is activated, the **PRO LOGIC II** indicator lights up on the display.

– For in-depth information about Dolby Pro Logic II modes, see “Creating Realistic Sound Fields” on pages 19 to 21.

DSP modes—CONCERT, STADIUM, HALL, THEATER, LIVE HOUSE

To activate DSP modes

Press **DSP**.

The current DSP mode appears on the display for a while.



- Each time you press the button, DSP mode changes as follows:

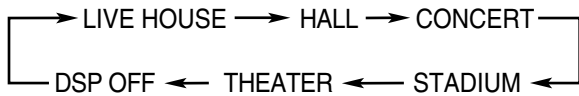

– For in-depth information about DSP modes, see “Creating Realistic Sound Fields” on pages 19 to 21.

Note:

Before activating the Surround or DSP mode, adjust the speaker setting to bring out the best performance from this system. For in-depth information about adjusting the speaker setting, see “Setting Menu” on pages 55 and 56.

To turn off the power (into standby)

Press **AUDIO** (or /STANDBY/ON on the front panel) again.



The illumination lamp goes off and the STANDBY lamp lights up.

- A small amount of power is consumed even in standby mode. To turn the power off completely, unplug the AC power cord.

Other Basic Operations

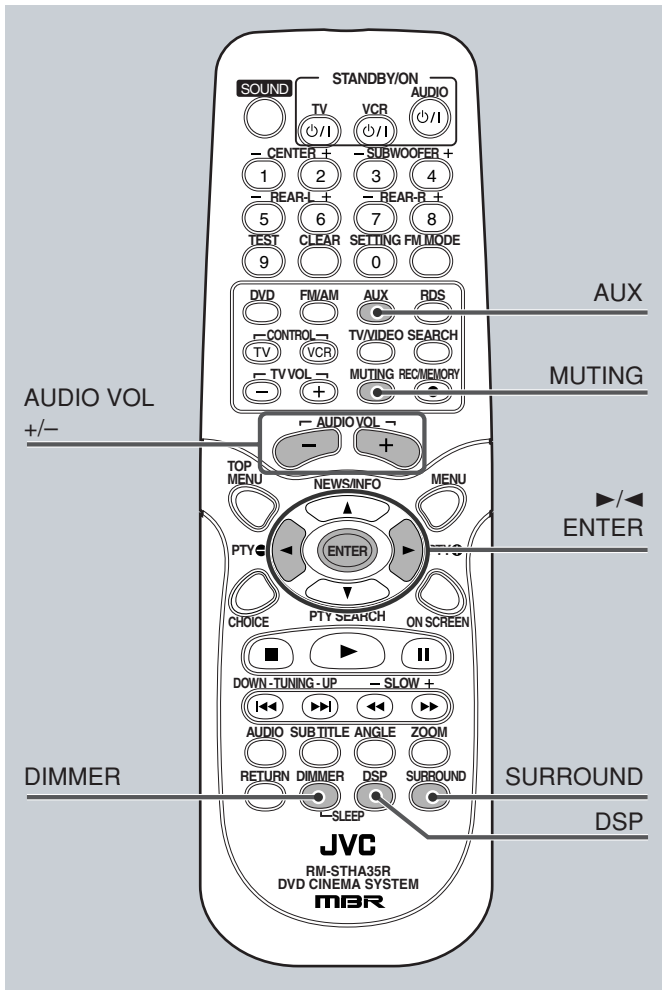

Enjoying Sounds from the External Component

You can enjoy sounds from the external equipment connected to the OPTICAL DIGITAL IN terminal or ANALOG IN jacks on the rear panel of the center unit, or TV connected with SCART cable.

1 Select AUX as the source.

From the remote control:

Press **AUX**.

- Each time you press the button, the source changes as follows:



DIGITAL IN : Select this to enjoy the external equipment connected to the OPTICAL DIGITAL IN terminal.

TV SOUND : Select this to enjoy the TV sound connected with SCART cable.

ANALOG IN : Select this to enjoy the external equipment connected to the ANALOG IN jacks.

On the front panel:

Press **SOURCE** repeatedly until “ANALOG IN,” “TV SOUND,” or “DIGITAL IN” appears on the display.



- Each time you press the button, the source changes as follows:

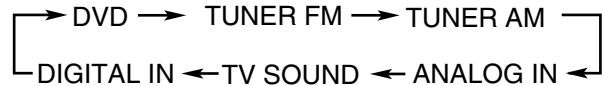

2 Start playback on the external equipment.

- For in-depth information about the external equipment, see the manual supplied for it

3 Adjust the Volume

From the remote control :

To increase the volume, press and hold **AUDIO VOL +**.

To decrease the volume, press and hold **AUDIO VOL -**.



On the front panel :

To increase the volume, turn **VOLUME** control clockwise.

To decrease the volume, turn **VOLUME** control counterclockwise.

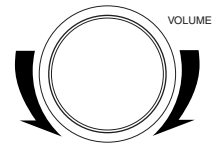

CAUTION:

Always set the volume to the minimum before starting any source. If the volume is set at its high level, the sudden blast of sound energy can permanently damage your hearing and/or ruin your speakers.

Notes:

- By pressing **AUDIO VOL +** or **-** repeatedly, you can adjust the volume level step by step.
- The volume level can be adjusted within 64 steps—“MIN (minimum),” 01 to 62 and “MAX (maximum).”
- If you have turned off the unit with the volume level set at more than level “25,” the volume level will be automatically set at level “25” next time you turn on the unit.

To turn off the sounds temporarily

From the remote control ONLY:

Press **MUTING**.



To restore the sound, press **MUTING** again.

- Pressing **AUDIO VOL +** or **-** also restores the sound.

4 Activate Surround or DSP Mode

You can enjoy three kinds of surround—Digital Multichannel Surround (Dolby Digital and DTS Digital Surround), Dolby Pro Logic II and DSP modes.

Digital Multichannel Surround—Dolby Digital and DTS Digital Surround

You can enjoy Dolby Digital or DTS Digital Surround when you playback Multichannel source on the external equipment.

To activate Dolby Digital or DTS Digital Surround

When playback source is encoded with Dolby Digital or DTS Digital Surround, the system detects it and activate Multichannel Surround automatically.

– For in-depth information about surround modes, see “Creating Realistic Sound Fields” on pages 19 to 21.

Dolby Pro Logic II—Pro Logic II Music and Pro Logic II Movie

To activate Pro Logic II modes

Press SURROUND.

The current Pro Logic II mode appears on the display for a while.

- Each time you press the button, Pro Logic II mode changes as follows:

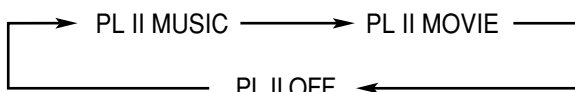

- When Dolby Pro Logic II mode is activated, the PRO LOGIC II indicator lights up on the display.

– For in-depth information about Dolby Pro Logic II modes, see “Creating Realistic Sound Fields” on pages 19 to 21.

DSP modes—CONCERT, STADIUM, HALL, THEATER, LIVE HOUSE

To activate DSP modes

Press DSP.

The current DSP mode appears on the display for a while.

- Each time you press the button, DSP mode changes as follows:

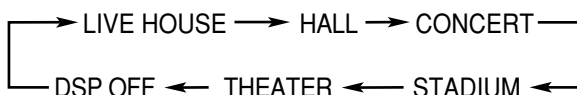

– For in-depth information about DSP modes, see “Creating Realistic Sound Fields” on pages 19 to 21.

Notes:

- On some source signals, no sounds come out from the subwoofer.
- Before activating the Surround or DSP mode, adjust the speaker setting to bring out the best performance from this system. For in-depth information about adjusting the speaker setting, see “Setting Menu” on pages 55 and 56.

Listening with the Headphones

You can enjoy the sound with headphones.

Connect a pair of headphones to the PHONES jack on the front panel. The speakers are deactivated and you can listen the sound with the headphones.

- Disconnecting a pair of headphones from the PHONES jack activate speakers.

CAUTION:

Be sure to turn down the volume:

- Before connecting or putting on headphones, as high volume can damage both the headphones and hearing.
- Before removing headphones, as high volume may output from the speakers.

Adjusting the Brightness

You can dim the indications on the display window and the illumination lamps on the center unit.

There is a time limit in doing the following steps. If the setting is canceled before you finish, start from step 1 again.

From the remote control ONLY:

- 1 Press DIMMER repeatedly until “DIMMER (with the current setting)” appears on the display.

- Each time you press the button, the indication in the main display changes as follows:

DIMMER* ← → SLEEP**

* With the current level is shown.

** With the remaining time is shown.

- 2 Press cursor / to adjust the brightness level.

- The brightness level changes as follows:

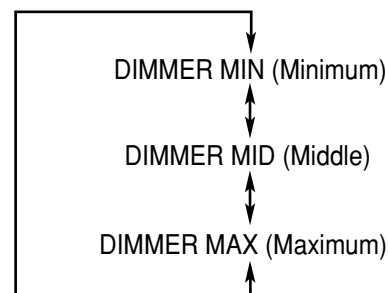

- 3 Press ENTER.

“OK” appears on the display and the brightness level changes.

Other Basic Operations

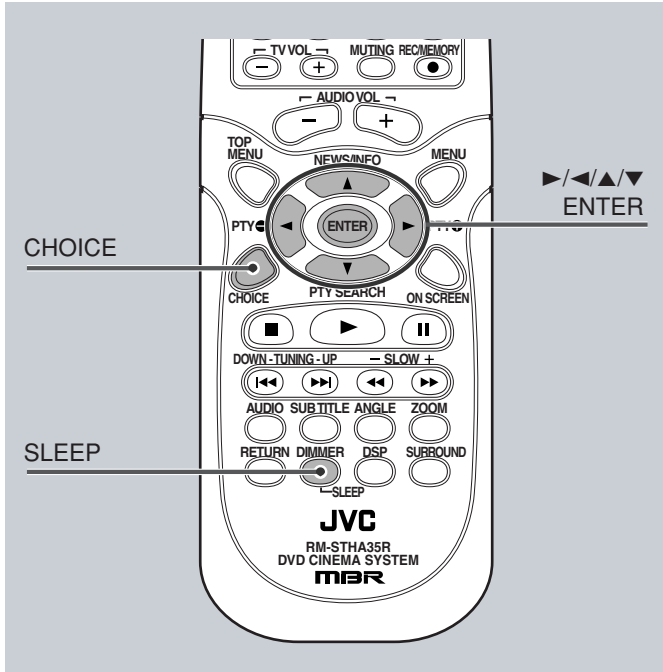

Turning Off the Power with the Timer

You can fall asleep while listening to music—Sleep Timer.

There is a time limit in doing the following steps. If the setting is canceled before you finish, start from step 1 again.

From the remote control ONLY:

1 Press SLEEP repeatedly until “SLEEP (with the remaining time)” appears on the display.

- Each time you press the button, the indication in the main display changes as follows:

DIMMER* ←→ SLEEP**

* With the current level is shown.

** With the remaining time is shown.

2 Press cursor ►/◄ to select the shut-off time.

- The shut-off time changes as follows:

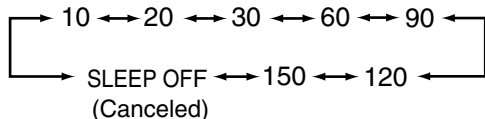

3 Press ENTER.

“OK” appears on the display and the sleep indicator lights up.

When the shut-off time comes, the system turns off automatically.

To check or change the time remaining until the shut-off time

Press SLEEP repeatedly until “SLEEP (with the remaining time)” appears on the display.

- You can change the shut-off time by pressing cursor ►/◄ then ENTER.



To cancel the Sleep Timer

Press cursor ►/◄ repeatedly until “SLEEP OFF” appears on the display in procedure above, then ENTER.

- Turning off the power also cancels the Sleep Timer.

Adjusting the Pictures

You can adjust parameters that affect the appearance of picture.

From the remote control ONLY:

1 Press CHOICE while playing back a disc.

Video Enhance menu appears on TV-screen.

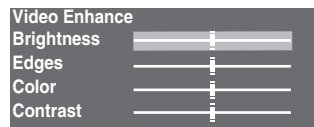

2 Press cursor ▲/▼ repeatedly to select a parameter you want to adjust.

- Adjust gradually to show preferable appearance by confirming the picture.

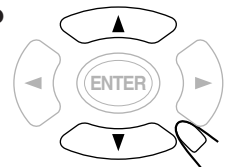

Brightness: Controls the brightness of the screen.

Edges: Controls the sharpness of the screen.

Color: Controls the color of the screen.

Contrast: Controls the contrast of the screen.

3 Press cursor ►/◄ repeatedly to change the setting.

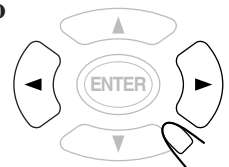

4 Press CHOICE.

Video Enhance menu disappears.



Note:

If you turn off the unit, the video enhance setting return to initial setting.

Creating Realistic Sound Fields

You can use the following surround to reproduce a realistic sound field.

- Dolby Surround
 - Dolby Pro Logic II
- Dolby Digital
- DTS Digital Surround
- DSP modes

■ Dolby Surround

Dolby Pro Logic II*

Dolby Pro Logic II has newly developed multichannel playback format to decode the 2 channel sources—stereo analog source, Linear PCM digital source, and Dolby Surround encoded source—into 5.1 channel.

Matrix-based encoding/decoding method for Dolby Pro Logic II makes no limitation for the cutoff frequency of the rear treble and enables stereo rear sound compared to conventional Dolby Pro Logic.

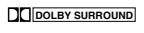
Dolby Pro Logic II enables to reproduce spacious sound from original sound without adding any new sounds and tonal colorations. Dolby Pro Logic II has two modes—**Movie mode** and **Music mode: Pro Logic II Movie (PL II MOVIE)**—suitable for reproduction of Dolby Surround encoded sources bearing the mark . You can enjoy sound field very close to the one created with discrete 5.1 channel sounds.

Pro Logic II Music (PL II MUSIC)—suitable for reproduction of any 2 channel stereo music sources. You can enjoy wide and deep sound by using this mode.

- When Dolby Pro Logic II is activated, the  PRO LOGIC II indicator lights up on the display window.

■ Dolby Digital*

Used to reproduce multichannel soundtracks of the software encoded with Dolby Digital ().

Dolby Digital 5.1 ch (DOLBY D) encoding method (so-called discrete multichannel digital audio format) records and digitally compresses the left front channel, right front channel, center channel, left rear channel, right rear channel, and LFE channel signals.

Since each channel is completely independent from the other channel signals to avoid interference, you can obtain much better sound quality with much stereo and surround effects.

When the system detects Dolby Digital signals, the  DIGITAL indicator lights up on the display.

Note:

Dolby Digital software can be roughly grouped into two categories—multichannel (up to “5.1” channel) and 2 channel software. To enjoy surround sounds while playing Dolby Digital 2 ch software, you can use Dolby Pro Logic II.

■ DTS Digital Surround* *

Used to reproduce multichannel sound tracks of the software encoded with DTS Digital Surround ().

DTS Digital Surround is another discrete 5.1 channel digital audio format available on CD, LD, and DVD software.

Compared to Dolby Digital, audio compression rate is relatively low. This fact allows DTS Digital Surround format to add breadth and depth to the reproduced sounds. As a result, DTS Digital Surround features natural, solid and clear sound.

When the system detects DTS Digital Surround signals, the **dts** indicator lights up on the display.

Example:

Indications on the display for each surround

• Dolby Digital



• DTS Digital Surround

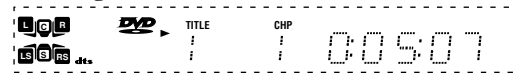

• Dolby Pro Logic II Music

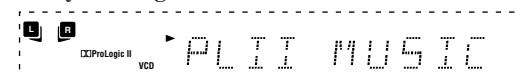

• Dolby Pro Logic II Movie



• DSP



* Manufactured under license from Dolby Laboratories. “Dolby,” “Pro Logic,” and the double-D symbol are trademarks of Dolby Laboratories. Confidential unpublished works. ©1992–1997 Dolby Laboratories. All rights reserved.

** “DTS” and “DTS Digital Surround” are registered trademarks of Digital Theater Systems, Inc.

Creating Realistic Sound Fields

DSP (Digital Signal Processor) Modes

DSP modes have been designed to create important acoustic surround elements.

The sound heard in a live house, a hall, a concert, a stadium, or a theater consists of direct sound and indirect sound—early reflections and reflections from behind. Direct sounds reach the listener directly without any reflection. On the other hand, indirect sounds are delayed by the distances of the ceiling and walls.

These indirect sounds are important elements of the acoustic surround effects.

The following DSP modes are provided with this unit.

LIVE HOUSE	: Gives the feeling of a live music house with a low ceiling.
HALL	: Gives clear vocal and the feeling of a concert hall.
CONCERT	: Gives the feeling of a large hall designated primarily for classical concert.
STADIUM	: Gives feeling of an outdoor stadium.
THEATER	: Gives the feeling of a theater.

These DSP modes can be used to add the acoustic surround effects while reproducing stereo analog software, Linear PCM digital software, or Dolby Surround encoded source and can give you a real “being there” feeling.

Note:

On some source signals, DSP mode may not work sufficiently. In that case, select another preferred DSP mode.

Activating the Surround Mode

You can enjoy three kinds of surround—Digital Multichannel Surround (Dolby Digital and DTS Digital Surround), Dolby Pro Logic II and DSP modes.

- If you activate the surround mode not available, “INVALID” appears on the display.

For Dolby Digital or DTS Digital Surround

When playback source is encoded with Dolby Digital or DTS Digital Surround, the system detects it and activate Multichannel Surround automatically.

- When Dolby Digital is activated, the **DIGITAL** indicator lights up on the display.
- When DTS Digital Surround is activated, the **dts** indicator lights up on the display.

For Pro Logic II modes

Press **SURROUND**.

The current Pro Logic II mode appears on the display for a while.



- Each time you press the button, Pro Logic II mode changes as follows:

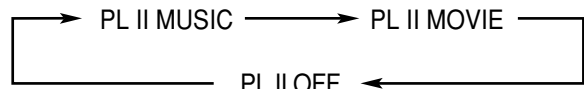

- When Dolby Pro Logic II mode is activated, the **PRO LOGIC II** indicator lights up on the display.

For DSP modes

Press **DSP**.

The current DSP mode appears on the display for a while.



- Each time you press the button, DSP mode changes as follows:

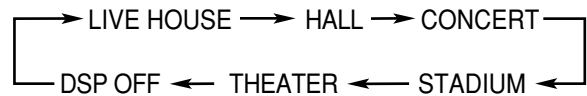

Available surround according to the input signal format

○: Possible ×: Impossible

Surround	Multichannel Surround	Pro Logic II		DSP					PL II OFF and DSP OFF (canceled)	
		PLII Movie	PLII Music	LIVE HOUSE	HALL	CONCERT	STADIUM	THEATER		
Input Signal format	Analog	×	○	○	○	○	○	○	○	○
	Linear PCM	×	○	○	○	○	○	○	○	○
	Dolby Digital Multichannel	○	×	×	×	×	×	×	×	—
	Dolby 2ch	×	○	○	○	○	○	○	○	○
	DTS Digital Surround	○	×	×	×	×	×	×	×	—
	DTS 2ch	×	×	×	×	×	×	×	×	○
	MP3	×	×	×	×	×	×	×	×	○

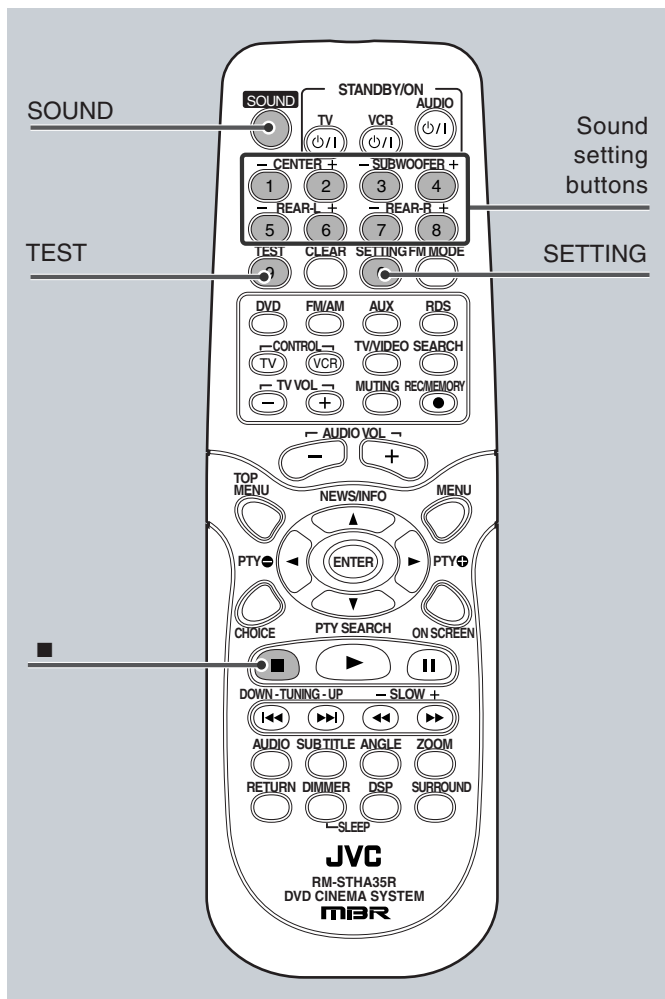

- The test tone comes out of the speakers in the following order:

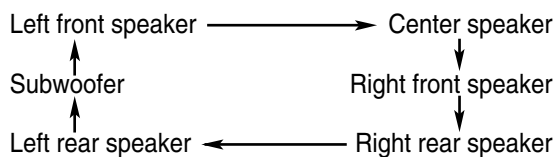

There is a time limit in doing the following steps. If the setting is canceled before you finish, press **SOUND** and start from step **4** again.

4 Adjust the speaker output levels (-6 dB to +6 dB).

Adjust the center speaker, rear speakers and subwoofer levels comparing to the sound from the front speakers.

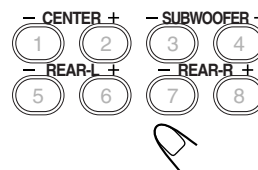

- To adjust the center speaker level, press CENTER +/-.
- To adjust the left rear speaker level, press REAR-L +/-.
- To adjust the right rear speaker level, press REAR-R +/-.
- To adjust the subwoofer level, press SUBWOOFER +/-.

5 Press STOP to stop the test tone.



6 Press SOUND again.

“SOUND OFF” appears on the display.



Adjusting the Sound

You can adjust the following settings.
It is recommended that you make adjustments from your actual listening point.

- Output level for the center speaker
- Output level for the rear speakers
- Output level for the subwoofer

1 Load a disc, and Press STOP.

The source changes to DVD and playback stops.



2 Press SOUND.

“SOUND” appears on the display and the 10 keys are activated for sound adjustments.



3 Press TEST to check if you can hear the sounds through all the speakers at the equal level.

Test tone menu appears on the TV.

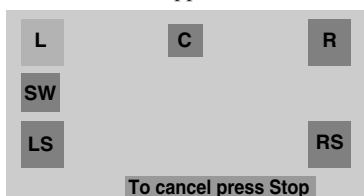

Notes:

- If a disc is not loaded, you cannot adjust the settings.
- You can adjust the speaker output levels without outputting the test tone.
- If there is a speaker from which no sounds comes out, check the speaker's connection (see pages 6 and 7) and setting (see pages 55 and 56).
- If you press SETTING while adjusting sound, speaker settings alternate between 5.1ch (use all satellite speakers and subwoofer) and 2.1ch (use only front speakers and subwoofer.)
- You can output the test tone in any surround mode, or even when surround mode is not activated.
- When an MP3 disc is loaded, you cannot adjust the subwoofer output level.

Disc Introduction—DVD/VCD/CD

This system has been designed to play back the following discs: DVD, Video CD, Super Video CD (SVCD), Audio CD, CD-R, and CD-RW.

- This system can also play back MP3 and JPEG files recorded on CD-Rs and CD-RWs. For in-depth information about MP3, see “MP3 Playback” on page 38, and about JPEG, see “JPEG Playback” on page 42.

Discs you can play:

Disc Type	Mark (Logo)	Video Format	Region Code Number*
DVD Video			2 ALL
Video CD		NTSC PAL	_____
Super Video CD			_____
Audio CD		_____	_____
CD-R		_____	_____
CD-RW		_____	_____

- On some DVD or VCD/SVCD discs, their actual operations may be different from what is explained in this manual. This is due to the disc programming and disc structure, but not a malfunction of this system.
- DVD-R discs recorded with the DVD VIDEO format can be played back. However, some discs may not be played back because of the disc characteristics or recording conditions. Note that unfinalized disc cannot be played back.
- The following discs cannot be played back:
 - DVD-Audio, DVD-ROM, DVD-RAM, DVD-RW, DVD+RW, CD-ROM, CD-I, (CD-I Ready), Photo CD, etc.
 Playing back these discs will generate noise and damage the speakers.

* Note on Region Code

DVD players and DVD Video discs have their own Region Code numbers. This system only can play back DVD discs whose Region Code numbers include “2.”

Examples:



If a DVD with the inadequate Region Code numbers is loaded, “Invalid Region” appears on the TV and playback cannot start.

IMPORTANT: Before performing any operations, make sure of the following...

- Check the connection with the TV.
- Turn on the TV and select the correct input on the TV to view the pictures or on-screen indications on the TV screen.
- For DVD playback, you can change the Setup menu setting to your preference. (See pages 52 to 57.)

If “⊗” appears on the TV screen when pressing a button, the disc cannot accept an operation you have tried to do, or information required for that operation is not recorded in the disc.
NOTICE : In some cases, without showing “⊗,” operations will not be accepted.

Disc structure—DVD, Video CD (VCD/SVCD) and Audio CD (CD)

A DVD disc consists of **Titles**, and each title may be divided into some **Chapters**. (See Example 1.)

For example, if a DVD disc contains some movies, each movie may have its own title number, and it may be further divided into some chapters.

On the other hand, a VCD/SVCD or CD consists of **Tracks**. (See Example 2.)

In general, each song has its own track number. (On some discs, each track may also be divided by Indexes.)

When playing back a VCD/SVCD with Playback Control (PBC) function, you can select what to view using the menu shown on the TV screen. (While operating a Video CD using the menu, some of the functions such as Repeat and Track Search may not work.)

Example 1: DVD disc

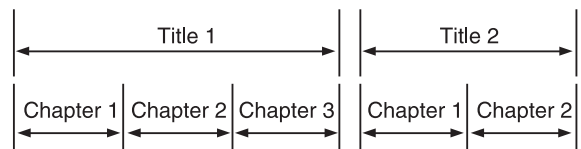

Example 2 : Video CD/Audio CD



Notes on CD-R and CD-RW

User-edited CD-Rs (Recordable) and CD-RWs (Rewritable) can be played back only if they are already “**finalized**.”

- The system can play back CD-Rs or CD-RWs recorded on a personal computer if they have been recorded in the audio CD format or recorded in MP3 format (see page 38). However, they may not be played back depending on their characteristics or recording conditions.
- Before playing back CD-Rs or CD-RWs, read their instructions or cautions carefully.
- Some CD-Rs or CD-RWs may not be played back on this unit because of their disc characteristics, damage or stain on them.
- CD-RWs may require a longer readout time. This is caused by the fact that the reflectance of CD-RWs is lower than for regular CDs.

Basic Disc Operations

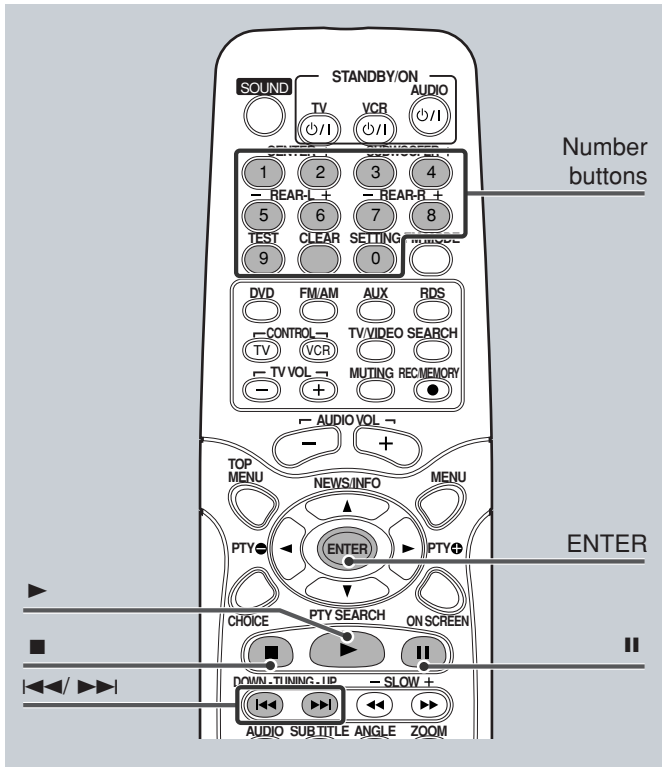

SVCD can be operated by using the VCD operation procedure.

To start playback

Press ►.

The source is automatically changed to the DVD player. "READING" appears on the display for a while, then the detected disc type appears—DVD, VCD, CD, MP3 or JPEG. (If your TV is turned on, the detected disc type appears on the TV screen.)

- When a disc is not loaded, "NO DISC" appears on the display.

Example: Playback information on the display

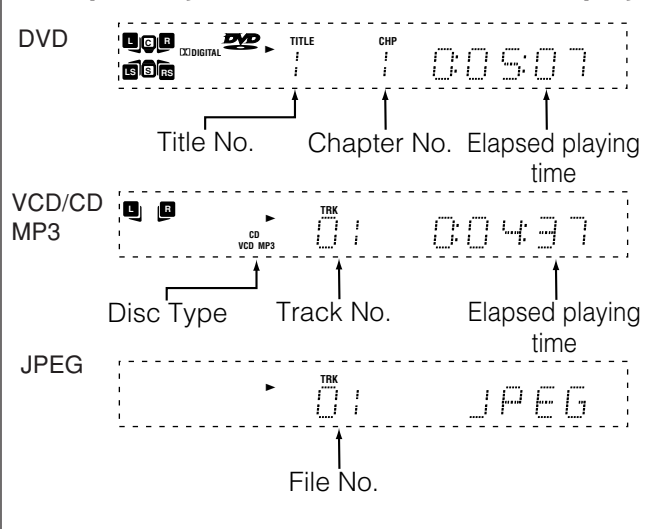

Disc play starts from the first chapter or track of the selected disc.

- If a menu appears while playing a DVD or VCD with PBC function, see "Disc Menu-Driven Playback" (for DVD) on page 26 or "Disc Menu-Driven Playback (Only for VCD)" on page 33.

Note:

If "Password ----" and "Parental Locked" appear on the TV screen, Parental Lock is in use. You cannot play back a DVD containing violent scenes or those not suitable for your family members. To play back such a disc, cancel the Parental Lock. (See page 57.)

To stop playback for a moment

Press ||.

- To resume play, press ►.



To go to another chapter or track

Press ►► or ◀◀ repeatedly during playback.

- ►► : Skips to the beginning of the next or succeeding chapter or track.
- ◀◀ : While an MP3 is played back
Goes back to the beginning of the previous track.

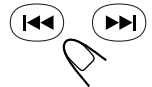

While a DVD, a CD, or a VCD is played back

Goes back to the beginning of the current or previous chapter or track.

To go to another track (only possible on a CD and VCD without PBC) directly using the number buttons

Pressing the number buttons during play allows you to start playing the track number you want.

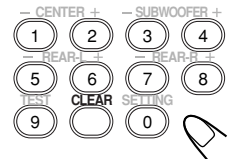

- To select number 1 to 9, press the corresponding number button, then press ENTER.
- To select number 15, press 1, 5, then press ENTER.
- To cancel a mis-entry, press CLEAR.

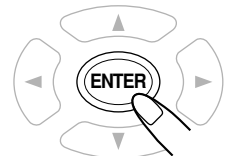

To stop during playback

Press ■.

When a DVD, a VCD, or a CD is played back

Playback stops (If your TV is turned on, "■ Resume Stop" appears on the TV screen.)

- This system can memorize the end point even when you press ■. When you start playback again by pressing ►, playback begins from where it has been stopped—Resume play.
- To stop completely, press ■ twice. ("■ Stop" appears on the TV screen.) The disc type appears on the display.



When an MP3 disc or JPEG disc is played back

Playback stops.

- This system can memorize the end point even when you press ■. When you start playback again by pressing ►, playback begins from the beginning of the stopped track—Resume play.

Note:

If you open the disc tray or turn off the unit, the resume play is canceled.

To remove the disc

Press ▲ on the front panel.

The disc tray comes out.



To close the disc tray, press ▲ again.

DVD Playback

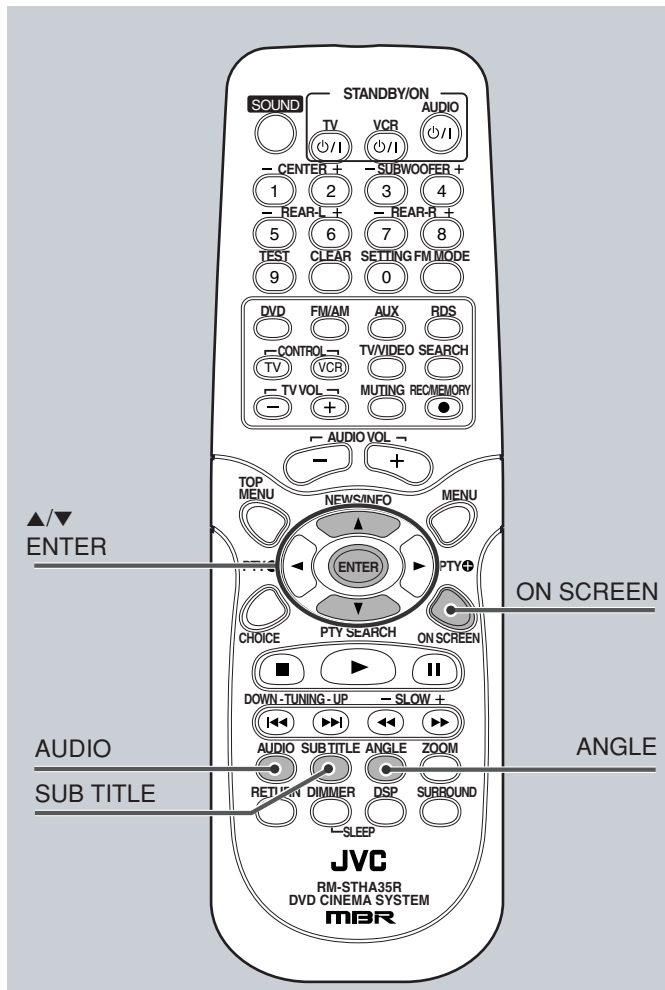

Some DVDs contain several audio languages, subtitles, and multi-angle views.
When you find the following marks on the DVD or its package, you can select these elements recorded on the DVD.

	Subtitles are recorded on the disc. The number inside the mark indicates the total number of the recorded subtitles.
	Several audio languages are recorded on the disc. The number inside the mark indicates the total number of the recorded audio languages.
	Multi-angle views are recorded on the disc. The number inside the mark indicates the total number of the recorded multi-angle views.

If you cannot find out whether your disc contains these features listed above, you can check it by showing the on-screen display (OSD.)

For basic disc operations such as inserting a disc, starting playback, and moving to another chapters, see "Basic DVD Operations" on pages 10, 11, and "Basic Disc Operations" on page 23.

Showing the On-screen Menu

You can use some functions through the on-screen menu.

From the remote control ONLY:

■ Whenever a disc is loaded.

Press ON SCREEN.

On-screen menu appears on the TV.

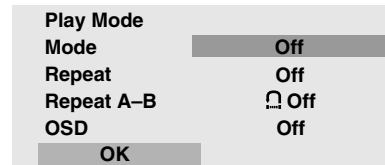

To turn off the on-screen menu

Press ON SCREEN again.

Showing the Information on the TV Screen

You can show the following information on the TV screen while a disc is loaded.

From the remote control ONLY:

1 Press ON SCREEN.

The on-screen menu appears on TV-screen.

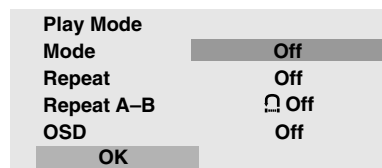

2 Press cursor ▲/▼ repeatedly to select "OSD."

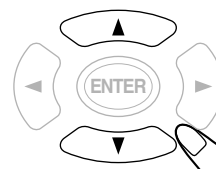
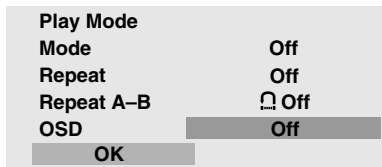

3 Press ENTER repeatedly to select the disc information.

- Each time you press the button, OSD changes as following:

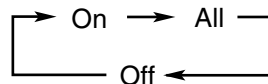

4 Press cursor ▲/▼ repeatedly to select "OK," then ENTER.

The on-screen menu disappears and the information appears on the TV.

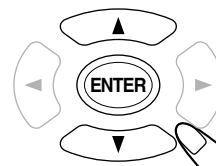

To turn off the disc information

- 1) Press ENTER repeatedly to select "Off" in step 3.
- 2) Press cursor ▲/▼ to select "OK", then press ENTER.

Disc information

OSD: On	① 00:01:16 01:40:45
OSD: All	① DVD 00:01:16 01:40:45 Title 1/15 Chapter 2/10 Angle 1/1 Audio 1/3 Eng 5.1ch 48KHz Subtitle Off
① : Elapsed playing time and remaining time	
② : Disc type	
③ : Current title and total number of the titles on the disc	<ul style="list-style-type: none"> • Ex.: 1st title is playing out of 15 titles recorded.
④ : Audio language indication	<ul style="list-style-type: none"> • Ex.: English is selected out of 3 audio languages recorded. See right column.
⑤ : Current chapter and total number of the chapters in the current title	<ul style="list-style-type: none"> • Ex.: 2nd chapter is playing out of 10 chapters recorded.
⑥ : Subtitle language indication	<ul style="list-style-type: none"> • Ex.: When no subtitle is displayed on the TV screen. See below.
⑦ : Signal format indicator	<ul style="list-style-type: none"> • Signal format type—Linear PCM (stereo), Dolby Digital, and DTS Digital Surround—and bit rate will be indicated. Ex.: When the disc is encoded with Dolby Digital 5.1 ch.
⑧ : Multi-angle view indicator	<ul style="list-style-type: none"> • Ex.: When only a single angle-view is recorded on the disc. See right column.

Selecting the Subtitles

While playing back a DVD containing subtitles in different languages, you can select the subtitle to be displayed on the TV screen.

- You can set your favorite subtitle language as the initial language shown on the screen. (See page 53.)

From the remote control ONLY:

Press **SUB TITLE**.

Subtitle language indicator appears on the TV screen for a while.

- Each time you press the button while the indicator appears on the TV screen, the subtitle language changes as follows:

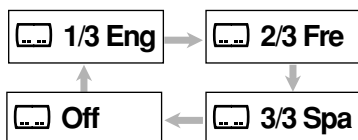

Ex.: When the disc has 3 selections—English, French, Spanish and no subtitle (OFF)

Selecting the Audio Languages

While playing back a DVD containing audio languages (sound track), you can select the language (sound track) to listen to.

- You can set your favorite audio language as the initial audio language. (See page 53.)

From the remote control ONLY:

Press **AUDIO**.

Audio language indicator appears on the TV screen for a while.

- Each time you press the button while the indicator appears on the TV screen, the audio language changes as follows:

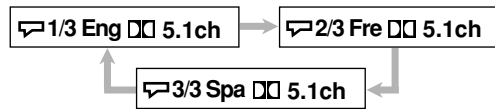

Ex.: When the disc has 3 selections—English, French, and Spanish

Selecting the Multi-Angle Views

While playing back a DVD containing multi-angle views, you can view the same scene at different angles.

From the remote control ONLY:

Press **ANGLE**.

The angle indicator appears on the TV screen for a while.

- Each time you press the button while the angle indicator appears on the TV screen, the view angle changes.

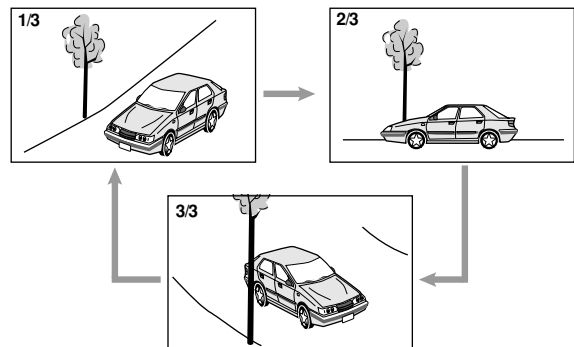

Ex.: When the disc has 3 multi-angle views

DVD Playback

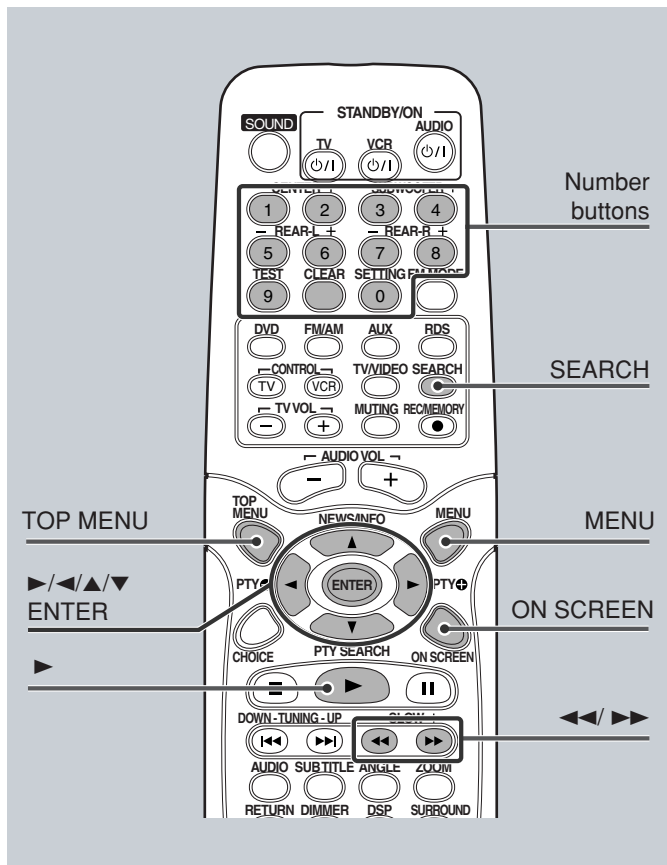

Moving to a Particular Portion Directly

You can move to another title, chapter, or particular scene in the chapter directly.

From the remote control ONLY:

1 Press SEARCH.

The search menu appears on the TV.



2 Press cursor ▲/▼ to select the item.

- Time :** Select this to move to a particular scene.
- Title:** Select this to move to another title.
- Chapter:** Select this to move to another chapter.

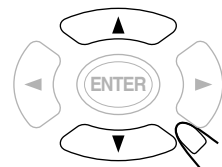

3 Press the number buttons to select a desired title, chapter, or playing time.

The unit starts playback of the selected item.

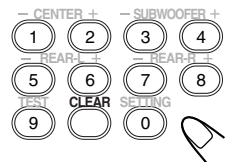

Disc Menu-Driven Playback

Disc menu-driven playback is possible while playing back a DVD with menu (menu may be still pictures or moving pictures depending on the disc).

- When operating a disc using the disc menu, refer also to the instructions supplied for the disc.

DVD discs generally have their own menus or title lists. A menu usually contains various information about the disc and playback selections. On the other hand, a title list usually contains titles of movies and songs recorded.

From the remote control ONLY:

1 Press MENU or TOP MENU.

A menu or title list will appear on the screen.

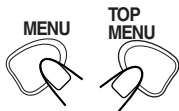

- On some DVDs, a menu will automatically appear on the screen after playback starts.

2 Select a desired item on the menu or on the title list, using cursor ►/◄/▲/▼ and ENTER.

The unit starts playback of the selected item.

- On some discs, you can also select items by pressing the number buttons corresponding to the item numbers listed.

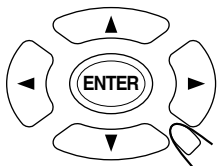

How to input the title and chapter number

Press the number buttons corresponding to the number, then press ENTER to start playback.

- To select number 5, press 5, then ENTER.
- To select number 12, press 1, 2, then ENTER.
- To select number 22, press 2, 2, then ENTER.
- To cancel a mis-entry, press CLEAR.

How to input the playing time

Press the number buttons to input the playing time, then press ENTER to start playback at the selected elapsed playing time.

- To input time "00:45:23," press 4, 5, 2, 3, then ENTER.
- To input time "01:23:45," press 1, 2, 3, 4, 5, then ENTER.
- To cancel a mis-entry, press CLEAR.

Searching for a Particular Point

You can search for a particular portion while playing a disc—Variable Speed Forward/Reverse Search.

- No sound comes out during Variable Speed Forward/Reverse Search.

To fast-forward the chapter—Variable Speed Forward Search

From the remote control ONLY:

Press **▶▶** during playback.

- Each time you press the button, the search speed changes as follows:

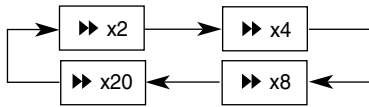

To resume normal play

Press **▶**.



To reverse the chapter—Variable Speed Reverse Search

From the remote control ONLY:

Press **◀◀** during playback.

- Each time you press the button, the search speed changes as follows:

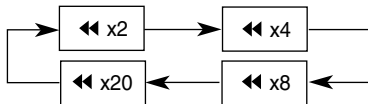

To resume normal play

Press **▶**.



Repeating Playback

Repeat play cannot be used in the following cases:

- When you enjoy program play

Repeat Play

From the remote control ONLY:

1 Press ON SCREEN.

The on-screen menu appears on the TV.

Play Mode	
Mode	Off
Repeat	Off
Repeat A-B	Off
OSD	Off
OK	



2 Press cursor ▲/▼ to select “Repeat.”

Play Mode	
Mode	Off
Repeat	Off
Repeat A-B	Off
OSD	Off
OK	

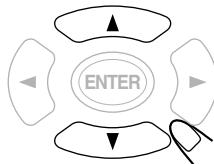

3 Press ENTER repeatedly to select the repeat mode.

- Each time you press the button, Repeat mode changes as follows:

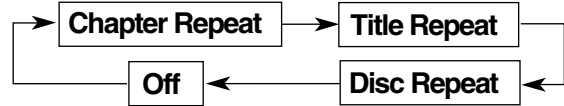
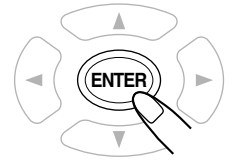

Chapter Repeat:

Current chapter will be repeated. (the REPEAT 1 indicator lights up.)

Title Repeat:

Current title will be repeated. (the REPEAT indicator lights up.)

Disc Repeat:

Disc will be repeated. (the REPEAT indicator lights up.)

Off:

Repeat play is canceled. (Normal play is resumed.)

4 Press cursor ▲/▼ to select “OK,” then ENTER.

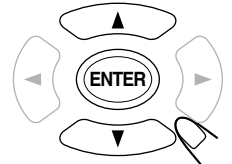

To cancel repeat play

- 1) Press ENTER repeatedly to select “Off” in step 3.
- 2) Press cursor ▲/▼ to select “OK,” then press ENTER.

A-B Repeat

While playing, you can also select a portion you want to repeat.

- A-B repeat is not performed between different titles.

Example:

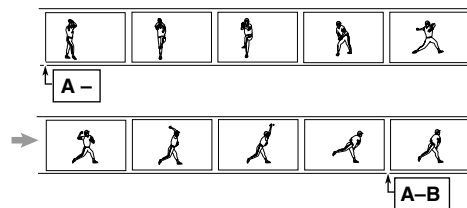

From the remote control ONLY:

1 Press ON SCREEN.

The on-screen menu appears on the TV.

Play Mode	
Mode	Off
Repeat	Off
Repeat A-B	Off
OSD	Off
OK	



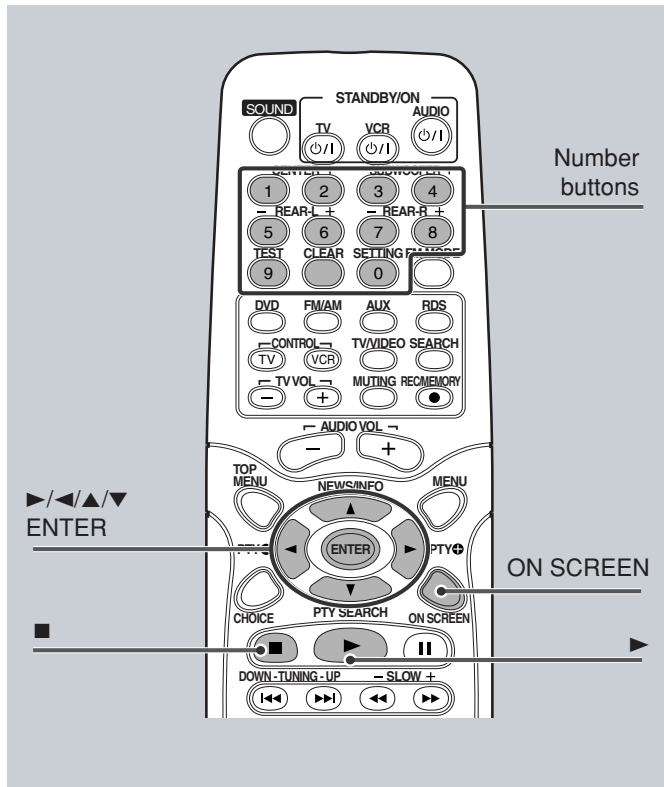

Playing Back Chapters in Random Order — Shuffle Play

You can playback chapters in random order.

From the remote control ONLY:

1 Press ON SCREEN.

The on-screen menu appears on the TV.

Play Mode	
Mode	Off
Repeat	Off
Repeat A-B	Off
OSD	Off
OK	



2 Press cursor ▲/▼ to select “Mode.”

Play Mode	
Mode	Off
Repeat	Off
Repeat A-B	Off
OSD	Off
OK	

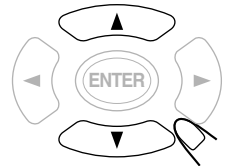

3 Press ENTER repeatedly to select “Shuffle.”

- Each time you press the button, play mode changes as follows:

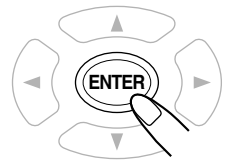
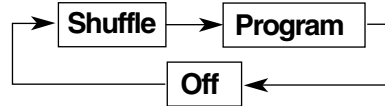

4 Press cursor ▲/▼ to select “OK”, then press ENTER.

The on-screen menu disappears.

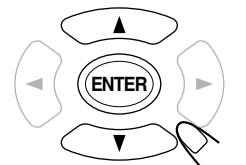

2 Press cursor ▲/▼ to select “Repeat A-B.”

Play Mode	
Mode	Off
Repeat	Off
Repeat A-B	Off
OSD	Off
OK	

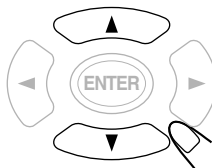

3 Press ENTER to select the start point.

“A-” appears on the display and “A-” appears on the TV.

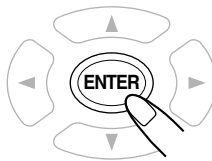

4 Press ENTER again to select the end point.

“A-” changes to “A-B”, then A-B repeat begins. The unit automatically locates point A and starts repeated playback between points A and B.

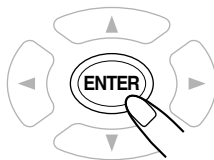

5 Press ON SCREEN again.

The on-screen menu disappears.



5 Press ►.

Playback starts in random order.



To cancel A-B Repeat

- 1) Press ENTER repeatedly to select “Off” in step 3.
- 2) Press cursor ▲/▼ to select “OK”, then press ENTER. “A-B” disappears, and resume normal playback.

To cancel shuffle play

- 1) Press ENTER repeatedly to select “Off” in step 3.
- 2) Press cursor ▲/▼ to select “OK”, then press ENTER.

Notes:

- When all chapters in the current title have been played once, shuffle play ends.
- The same chapter will not be played more than once during shuffle play.

Programming the Playing Order of the Chapters — Program Play

You can arrange the chapter playback order before you start playing. You can program up to 12 steps.

From the remote control ONLY:

1 Press ON SCREEN.

The on-screen menu appears on the TV.

Play Mode	
Mode	Off
Repeat	Off
Repeat A-B	Off
OSD	Off
OK	



2 Press cursor ▲/▼ to select “Mode.”

Play Mode	
Mode	Off
Repeat	Off
Repeat A-B	Off
OSD	Off
OK	

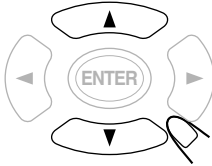

3 Press ENTER repeatedly to select “Program.”

- Each time you press the button, play mode changes as follows:

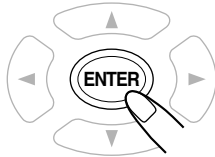
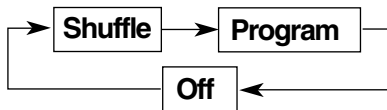

4 Press cursor ▲/▼ to select “OK”, then press ENTER.

The Program menu appears on the TV.

Program	Title Number	Chapter Number	Title/Chapter
1	2	4	7 10
2	5	8	11
3	6	9	12
Play Program Clear All			

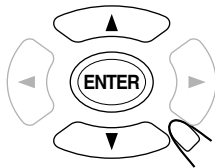

5 Press the number button to enter a title number.

Program	Title/Chapter
1 2	4 7 10
2	5 8 11
3	6 9 12
Play Program Clear All	

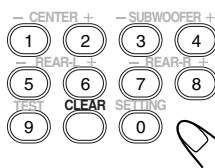

- To select number 5, press 5.
- To select number 12, press 1, 2.
- To cancel a mis-entry, press CLEAR.

6 Press cursor ► to select the chapter number.

Program	Title/Chapter
1 2	4 7 10
2	5 8 11
3	6 9 12
Play Program Clear All	

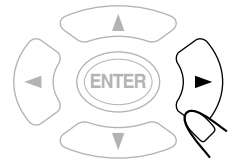

7 Press the number button to enter the chapter number.

Program	Title/Chapter
1 2 3	4 7 10
2	5 8 11
3	6 9 12
Play Program Clear All	

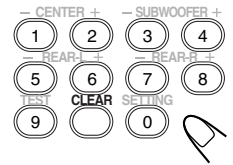

- To select number 5, press 5.
- To select number 12, press 1, 2.
- To cancel a mis-entry, press CLEAR.

8 Press cursor ►/◀/▲/▼ to select next program step number.

Program	Title/Chapter
1 2 3 4	7 10
2	5 8 11
3	6 9 12
Play Program Clear All	

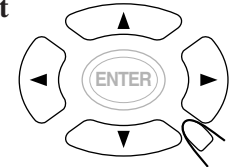

9 Repeat steps 5 to 8 to program other chapters you want.

10 Press cursor ►/◀/▲/▼ to select “Play Program”, then press ENTER.

The Program menu disappears and PROG indicator appears on the display. The chapters are played in the order you have programmed.

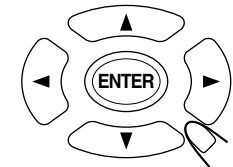

To stop during playback

Press ■.



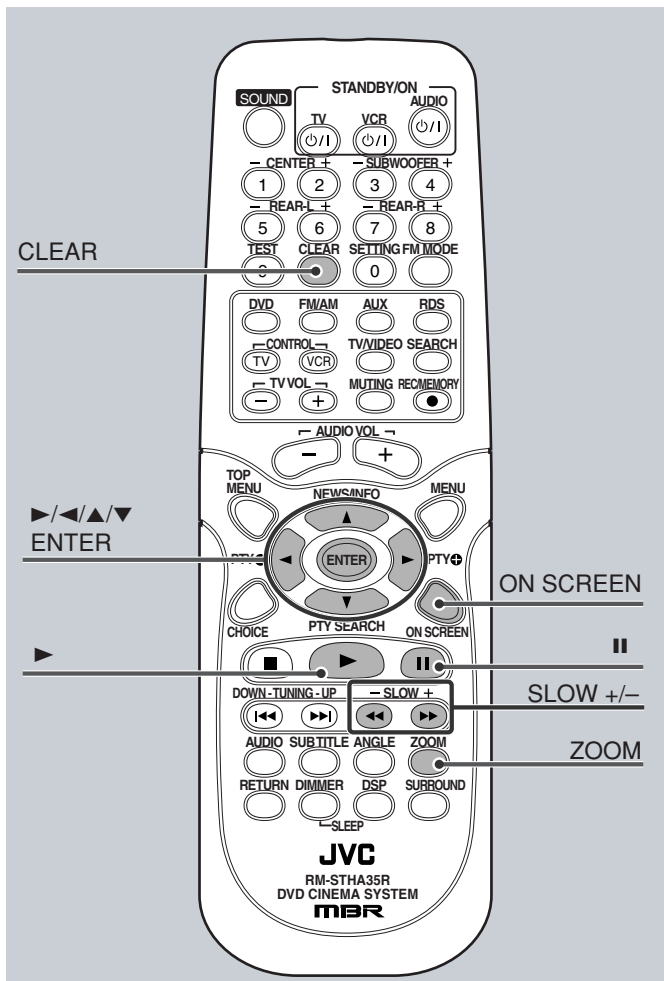

To exit from program play

From the remote control ONLY:

- 1) Press ENTER repeatedly to select “Off” in step 3 on page 29.
- 2) Press cursor ▲/▼ to select “OK”, then ENTER.

To check the program contents

- 1) Press ON SCREEN.
 - 2) Press cursor ▲/▼ to select “Mode.”
 - 3) Press ENTER repeatedly to select “Program” again even though “Program” is selected in Step 2.
 - 4) Press cursor ▲/▼ to select “OK”, then ENTER.
- The program menu appears on the TV.

To disappear program contents, press ON SCREEN twice.

To erase the stored program

- 1) Repeat steps 1 to 4 on page 29.
- 2) Press cursor ►/◄/▲/▼ to select “Clear All”, then ENTER.

To modify the program

You can modify the program while the program menu screen is shown on the TV screen.

- **To erase a step:** Press cursor ►/◄/▲/▼ to select (highlight) an title or chapter in unwanted step, then press CLEAR.
- **To modify a step:** Press cursor ►/◄/▲/▼ to select (highlight) a title or chapter you want to modify, then perform steps 5 to 8 on page 29. (Before entering a new number, press CLEAR)
- **To add a step:** Press cursor ►/◄/▲/▼ to select (highlight) an empty program step, then perform steps 5 to 8 on page 29.

DVD Special Effect Playback

■ Still Picture/Frame-by-Frame Playback

You can advance the still picture frame by frame while playing a DVD.

From the remote control ONLY:

1 Press II once during playback.

A still picture appears on the TV screen.

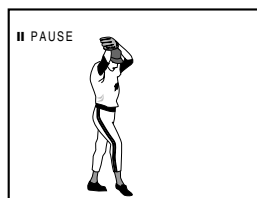

2 Press II repeatedly to advance the picture frame by frame.

- Each time you press the button, the picture advances frame by frame.



To resume normal play

Press ►.



■ Slow Motion Playback

You can enjoy slow motion playback while playing a DVD.

From the remote control ONLY:

1 Press **II** at the point where you want to start playback in slow-motion.

A still picture appears on the TV screen.



2 Press **SLOW +** or **SLOW -**.

- Each time you press the button, slow motion speed changes as follows.

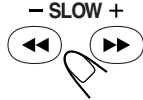

Forward:

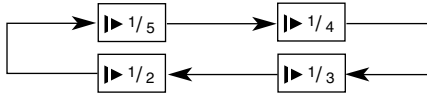

Reverse:

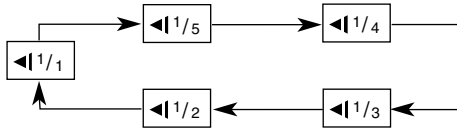

■ Zoom

You can zoom on the picture while playing back a DVD.

From the remote control ONLY:

1 Press **ZOOM**.

The zoom indicator appears on the TV.

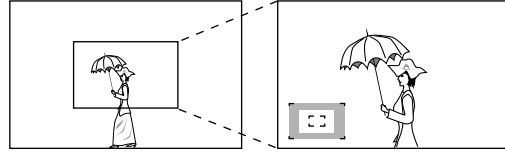

- Each time you press the button while the indicator appears, the magnification changes as follows:

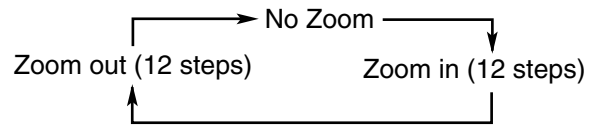

2 Press cursor **▶/◀/▲/▼** to move the portion you want to watch.

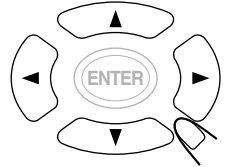

To cancel the zoom

Press **▶**.

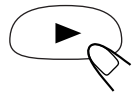

VCD/CD Playback

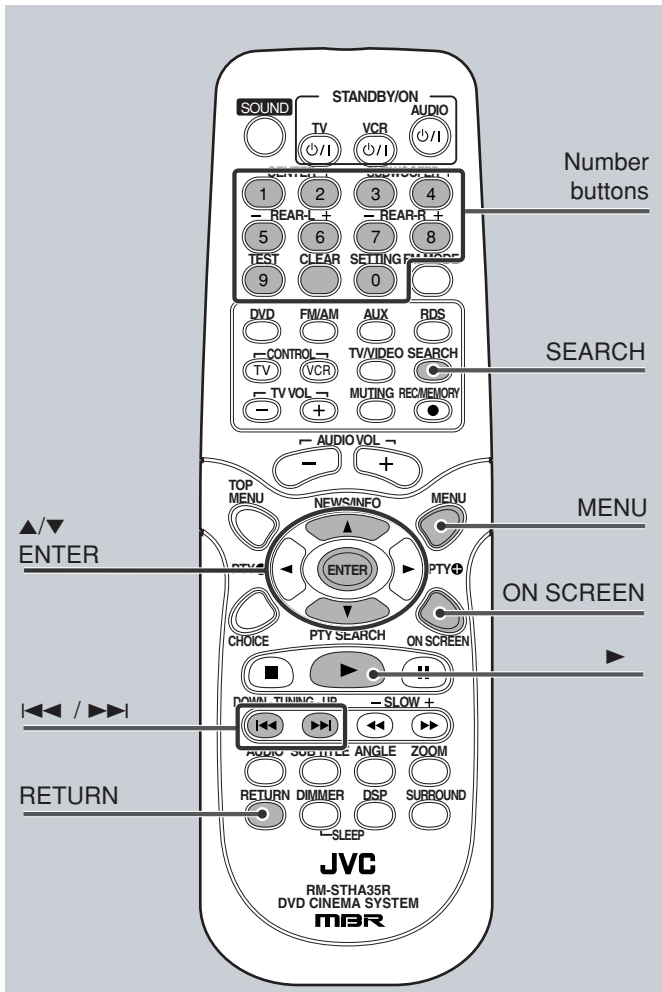

- SVCD can be operated by using the VCD operation procedure.
- For basic disc operations such as inserting a disc, starting playback, and moving to another tracks, see “Basic VCD/CD Operations” on pages 12, 13, and “Basic Disc Operations” on page 23.

Showing the On-screen Menu

You can use some functions through the on-screen menu.

- Whenever a disc is loaded. Press ON SCREEN.

The on-screen menu appears on the TV.



Play Mode	
Mode	Off
Repeat	Off
Repeat A-B	Off
OSD	Off
OK	

To turn off the on-screen menu

Press ON SCREEN again.

Showing the Information on the TV Screen

You can show the following information on the TV screen while a disc is loaded.

From the remote control ONLY:

1 Press ON SCREEN.

The on-screen menu appears on TV-screen.



Play Mode	
Mode	Off
Repeat	Off
Repeat A-B	Off
OSD	Off
OK	

2 Press cursor ▲/▼ repeatedly to select “OSD.”

Play Mode	
Mode	Off
Repeat	Off
Repeat A-B	Off
OSD	Off
OK	

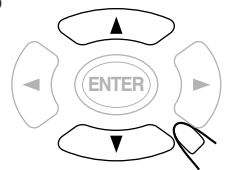

3 Press ENTER repeatedly to select the disc information.

- Each time you press the button, OSD changes as following:

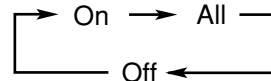
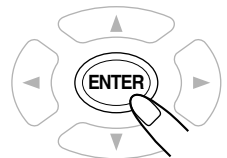

4 Press cursor ▲/▼ repeatedly to select “OK,” then ENTER.

The on-screen menu disappears and the information appears on the screen.

To turn off the disc information

- 1) Press ENTER repeatedly to select “Off” in step 3.
- 2) Press cursor ▲/▼ to select “OK”, then press ENTER.

Disc information

OSD: On	① 00:01:16 01:06:35
OSD: All	② ③ ① VCD 2.0 Track 1/15 00:01:16 01:06:35
① : Elapsed playing time and remaining time	
② : Disc type and VCD version number • VCD version number appears when only VCD is loaded (On some VCD, the version number is not shown).	
③ : Current track and total number of the tracks on the disc • Ex.: 1st track is playing out of 15 tracks recorded.	

Disc Menu-Driven Playback (Only for VCD)

The Play Back Control function (PBC) allows you to operate the VCD using menus.

When you start playing a VCD with PBC function, a menu will automatically appear on the TV screen.

- A menu may be a list of items, divided screens, or some moving pictures. (See “PBC operation concept” below.)

When a menu appears, you can select a desired item on the menu.

- When a list of items is displayed on the TV screen, press the number buttons to select an item.
- When “▶” or “SELECT” is displayed on the TV screen, press ▶ to start playback.

From the remote control ONLY:

To go to the next submenu

Press ▶▶.



To return to the previous submenu

Press ◀◀.

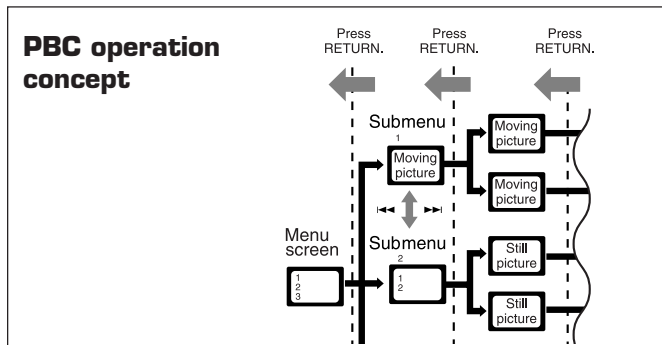

From the remote control ONLY:

To cancel the PBC playback

You can turn on and off the PBC function by pressing MENU on the remote control. Each time you press the button, the PBC function turns on and off.



Note:

If you select shuffle play, program play, or repeat play, the PBC function is canceled.

To activate the PBC function

- 1) Press ON SCREEN.
- 2) Press cursor ▲/▼ to select “Mode.”
- 3) Press ENTER repeatedly to select “PBC.”
- 4) Press cursor ▲/▼ to select “OK,” then press ENTER.

Selecting Playback Channel

When you play back VCD or CD, you can only select either the left channel or right channel to listen to.

Press AUDIO repeatedly.

Each time you press the button, the sound mode changes as follows:



Stereo ➔ Left channel ➔ Right channel
➔ (back to the beginning)

Notes:

- While activating Surround mode or DSP mode, this function does not work.
- On some discs, this function does not work.

Moving to a Particular Portion Directly

You can move to a particular portion (scene) on the track directly.

- PBC function is canceled when you use this function.

From the remote control ONLY:

1 Press SEARCH during playback or pause.

- Each time you press the button, the following indication appears on the TV screen.

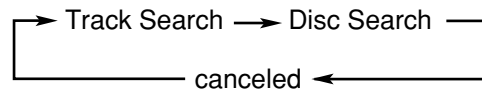

2 Press cursor ▲/▼ to select the item (only for Disc search.)

Track Search:

Time : Select this to move to a particular portion on the current track.

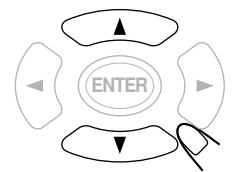

Disc Search:

Time : Select this to move to a particular portion on the current disc.

Track: Select this to move to a particular track on the current disc.

3 Press number buttons to select a desired track or playing time.

The unit starts playback of the selected item.

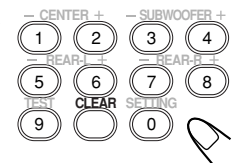

How to input the playing time

- To input time “09:45,” press 9, 4, 5, then ENTER.
- To input time “45:23,” press 4, 5, 2, 3, then ENTER.
- To cancel a misentry, press CLEAR.

How to input the track number

Press the number buttons corresponding to the number, then press ENTER to start playback.

- To select number 5, press 5, then ENTER.
- To select number 12, press 1, 2, then ENTER.
- To cancel a misentry, press CLEAR.

Note:

When playing back is stopped, you can use only Disc Search.

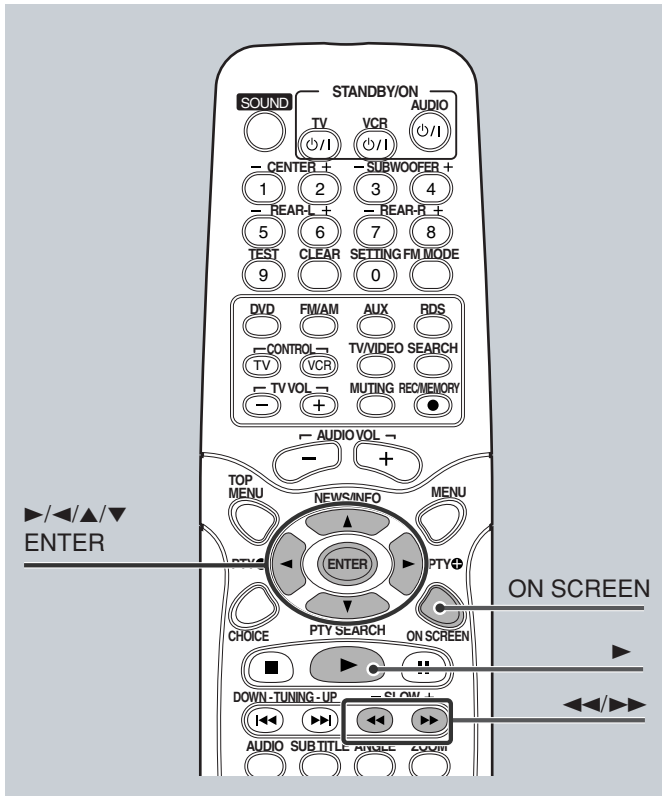

Searching for a Particular Point

You can search for a particular portion while playing a disc—Variable Speed Forward/Reverse Search.

- No sound comes out during Variable Speed Forward/Reverse Search on a VCD.

To fast-forward the tracks—Variable Speed Forward Search

From the remote control ONLY:

Press **▶▶** during playback.

- Each time you press the button, the search speed changes as follows:

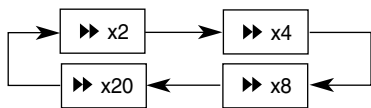

To resume normal play

Press **▶**.

To reverse the tracks—Variable Speed Reverse Search

From the remote control ONLY:

Press **◀◀** during playback.

- Each time you press the button, the search speed changes as follows:

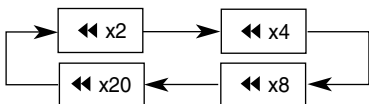

To resume normal play

Press **▶**.

Repeating Playback

Repeat play cannot be used in the following cases:

- When you enjoy program play

Repeat Play

From the remote control ONLY:

1 Press ON SCREEN.

The on-screen menu appears on the TV.



Play Mode	
Mode	Off
Repeat	Off
Repeat A-B	Off
OSD	Off
OK	

2 Press cursor ▲/▼ to select “Repeat.”

Play Mode	
Mode	Off
Repeat	Off
Repeat A-B	Off
OSD	Off
OK	

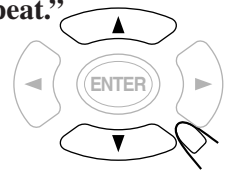

3 Press ENTER repeatedly to select the repeat mode.

- Each time you press the button, Repeat mode changes as follows:

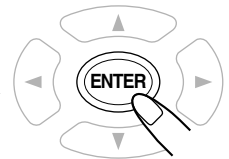
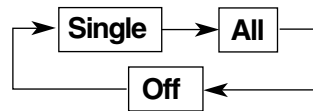

Single:

Current track be repeated. (REPEAT 1 indicator lights up.)

All:

Disc will be repeated. (REPEAT indicator lights up.)

Off:

Repeat play is canceled. (Normal play is resumed.)

4 Press cursor ▲/▼ to select “OK,” then ENTER.

The on-screen menu disappears and repeat playback starts.

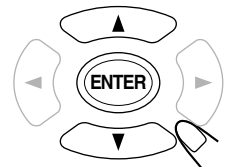

To cancel repeat play

- 1) Press ENTER repeatedly to select “Off” in step 3.
- 2) Press cursor ▲/▼ to select “OK”, then press ENTER.

■ A-B Repeat

While playing, you can also select a portion you want to repeat.

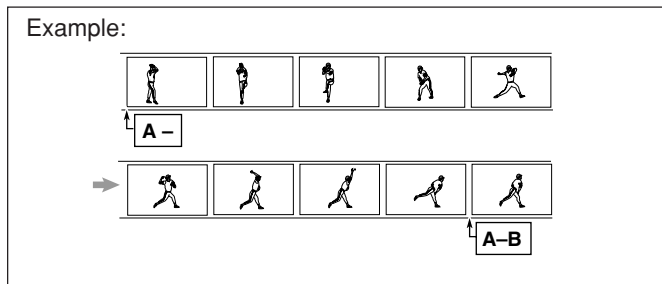

From the remote control ONLY:

1 Press ON SCREEN.

The on-screen menu appears on the TV.

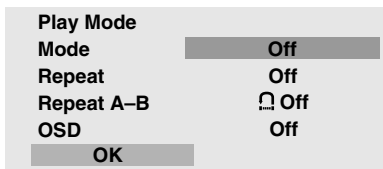

2 Press cursor ▲/▼ to select “Repeat A-B.”

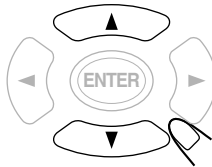
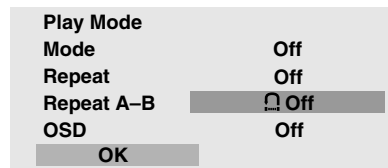

3 Press ENTER to select the start point.

“A-” appears on the display and “A-” appears on the TV.

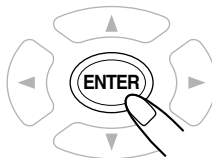

4 Press ENTER again to select the end point.

“A-” changes to “A-B”, then A-B repeat begins. The unit automatically locates point A and starts repeated playback between points A and B.

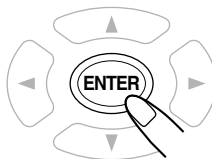

5 Press ON SCREEN again.

The on-screen menu disappears.



To cancel A-B Repeat

- 1) Press ENTER repeatedly to select “Off” in step 3.
- 2) Press cursor ▲/▼ to select “OK”, then press ENTER. “A-B” disappears, and resume normal playback.

Playing Back Tracks in Random Order — Shuffle Play

You can playback chapters in random order.

From the remote control ONLY:

1 Press ON SCREEN.

The on-screen menu appears on the TV.

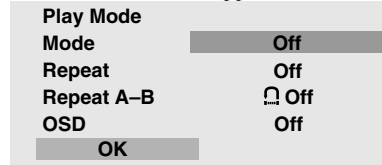

2 Press cursor ▲/▼ to select “Mode.”

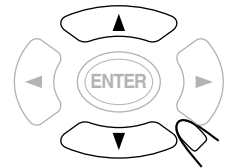
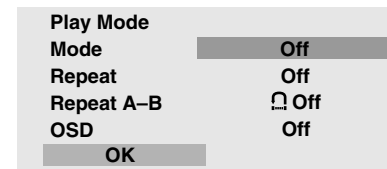

3 Press ENTER repeatedly to select “Shuffle.”

- Each time you press the button, play mode changes as follows:

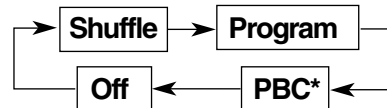

* Appears when only VCD with PBC is loaded

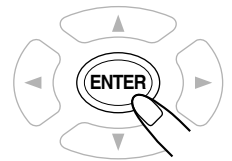

4 Press cursor ▲/▼ to select “OK”, then press ENTER.

The on-screen menu disappears.

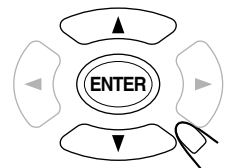

5 Press ►.

playback starts in random order.



To cancel shuffle play

- 1) Press ENTER repeatedly to select “Off” in step 3.
- 2) Press cursor ▲/▼ to select “OK”, then press ENTER.

Notes:

- When all tracks have been played once, shuffle play ends.
- The same track will not be played more than once during shuffle play.

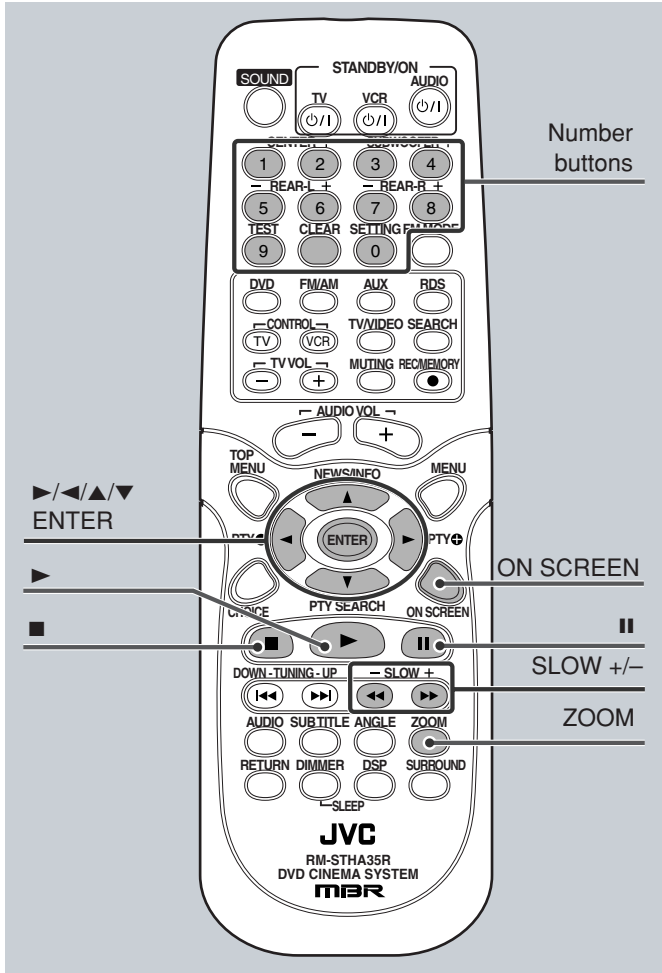

Programming the Playing Order of the Tracks — Program Play

You can arrange the track playback order before you start playing. You can program up to 12 steps.

From the remote control ONLY:

1 Press ON SCREEN.

The on-screen menu appears on the TV.

Play Mode	
Mode	Off
Repeat	Off
Repeat A-B	Off
OSD	Off
OK	



2 Press cursor ▲/▼ to select “Mode.”

Play Mode	
Mode	Off
Repeat	Off
Repeat A-B	Off
OSD	Off
OK	

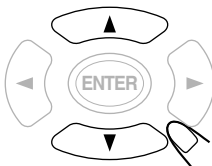

3 Press ENTER repeatedly to select “Program.”

- Each time you press the button, play mode changes as follows:

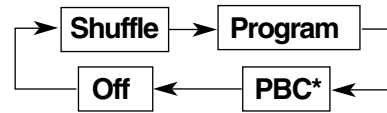

* Appears when only VCD with PBC is loaded

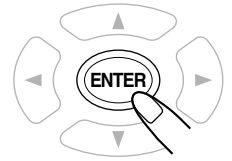

4 Press cursor ▲/▼ to select “OK”, then press ENTER.

The Program menu appears on the TV.

Track Number

Program				
1	---	4	---	10
2	---	5	---	11
3	---	6	---	12
Play Program		Clear All		

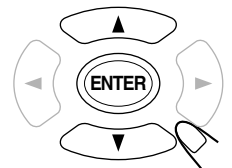

5 Press the number button to enter a track number.

Program				
1	12	4	---	10
2	---	5	---	11
3	---	6	---	12
Play Program		Clear All		

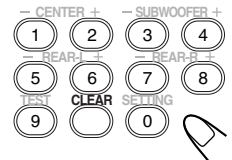

- To select number 5, press 5.
- To select number 12, press 1, 2.
- To cancel a mis-entry, press CLEAR.

6 Press cursor ►/◄/▲/▼ to select next program step.

Program				
1	12	4	---	10
2	---	5	---	11
3	---	6	---	12
Play Program		Clear All		

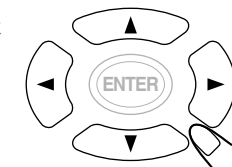

7 Repeat steps 5 to 6 to program other tracks you want.

8 Press cursor ►/◄/▲/▼ to select “Play Program”, then press ENTER.

The Program menu disappears and the PROG indicator appears on the display.

The tracks are played in the order you have programmed.

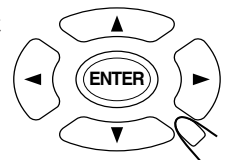

To stop during playback

Press ■.



To exit from program play

From the remote control ONLY:

- 1) Press ENTER repeatedly to select "Off" in step 3 on page 36.
 - 2) Press cursor ▲/▼ to select "OK", then press ENTER.
- Playback changes to normal play and the stored program is cleared.

To check the program contents

- 1) Press ON SCREEN.
- 2) Press cursor ▲/▼ to select "Mode."
- 3) Press ENTER repeatedly to select "Program" again even though "Program" is selected in Step 2.
- 4) Press cursor ▲/▼ to select "OK", then ENTER.

The program menu appears on the TV.

To disappear program contents, press ON SCREEN twice.

To erase the stored program

- 1) Repeat steps 1 to 4 on page 36.
- 2) Press cursor ►/◄/▲/▼ to select "Clear All", then ENTER.

To modify the program

You can modify the program while the program menu screen is shown on the TV.

- **To erase a step:** Press cursor ►/◄/▲/▼ to select (highlight) an unwanted track, then press CLEAR.
- **To modify a step:** Press cursor ►/◄/▲/▼ to select (highlight) a track you want to modify, then perform steps 5 to 6 on page 36 (Before entering a new number, press CLEAR)
- **To add a step:** Press cursor ►/◄/▲/▼ to select (highlight) an empty program step, then perform steps 5 to 6 on page 36.

VCD Special Effect Playback

Still Picture/Frame-by-Frame Playback

You can advance the still picture frame by frame while playing a VCD.

From the remote control ONLY:

1 Press II once during playback.

A still picture appears on the TV screen.

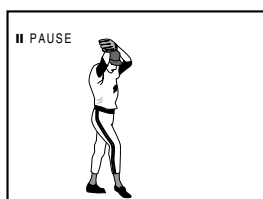

2 Press II repeatedly to advance the picture frame by frame.

- Each time you press the button, the picture advances frame by frame.



To resume normal play

Press ►.



Slow Motion Playback

You can enjoy slow motion playback while playing a VCD.

From the remote control ONLY:

1 Press II at the point where you want to start playback in slow-motion.

A still picture appears on the TV screen.



2 Press SLOW +.

- Each time you press the button, slow motion speed changes as follows.

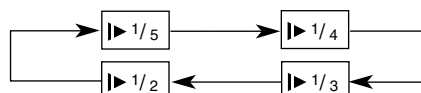

To resume normal play

Press ►.



Zoom

You can zoom on the picture while playing back a VCD.

From the remote control ONLY:

1 Press ZOOM.

The zoom indicator appears on the TV.

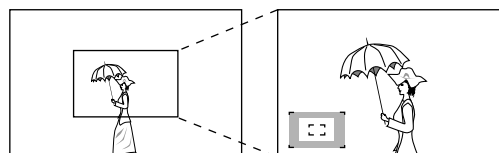

- Each time you press the button while the indicator appears, the magnification changes as follows:

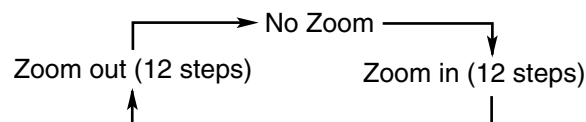

2 Press cursor ►/◄/▲/▼ to move the portion you want to watch.

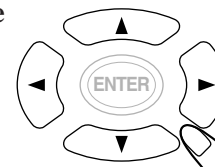

To cancel the zoom

Press ►.



MP3 Playback

This system is incorporated with an MP3 decoder. You can playback MP3 tracks (files) recorded on CD-Rs, CD-RWs, and CD-ROMs.

- Notice that “files” and “tracks” are used interchangeably.

What is MP3?

MP3 is an abbreviation of Motion Picture Experts Group (or MPEG) Audio Layer 3. MP3 is simply a file format with a data compression ratio of 1:10 (128 Kbps*). That means, by using MP3 format, one CD-R or CD-RW can contain 10 times as much data volume as a regular CD can.

* Bit rate is the average number of bits that one second of audio data will consume. The measuring unit used is Kbps (1000 bits per second).

To get a better audio quality, choose a higher bit rate. The most popular bit rate for encoding (recording) is 128 Kbps.

MP3 File Compatibility

- This system can only read MP3 files that are recorded in the format that is compliant with ISO 9660 Level 1 or Level 2.
- The system can play MP3 files only with the following file extensions: “.MP3,” “.Mp3,” “.mp3,” and “.mp3.”
- This unit can show ID3v1* tags on the TV-screen.
- * An MP3 file can contain file information called “ID3 Tag” where its album name, performer, track title, etc. are recorded. There are two versions—ID3v1 (ID3 Tag version 1) and ID3v2 (ID3 Tag version 2).
- This unit is not compatible with ID3v2.

Disc structure—How are MP3 files recorded and played back?

“MP3 files (tracks)” can be recorded in “folders,” in PC terminology.

During recording, the files and folders can be arranged in a way similar to arranging files and folders of computer data.

“Root” is similar to the root of a tree. Every file and directory can be linked to the root.

In compliance with ISO 9660, the maximum allowable depth of nested folders—so-called “hierarchy”—is eight (inclusive of the root).

Playback order, files search order, and folder search order of the MP3 files recorded on a disc are determined by the writing (or encoding) application; therefore, playback order may be different from the one you have intended while recording the folders and the files.

NOTES for MP3 disc

- MP3 discs (either CD-R or CD-RW) require a longer readout time. (It differs due to the complexity of the folder/file configuration.)
- When an MP3 disc is loaded, you cannot adjust the subwoofer output level.

Example: MP3 disc structure and playback order

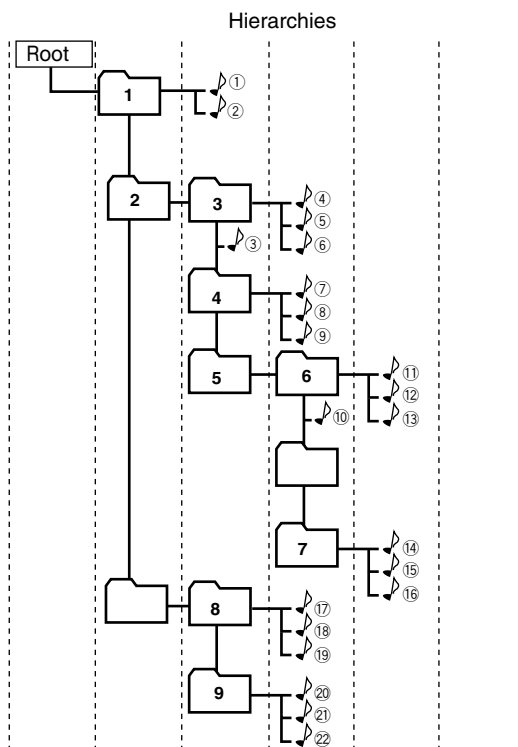

- Ⓛ : Indicates folders
- 🎵 : Indicates files (tracks)

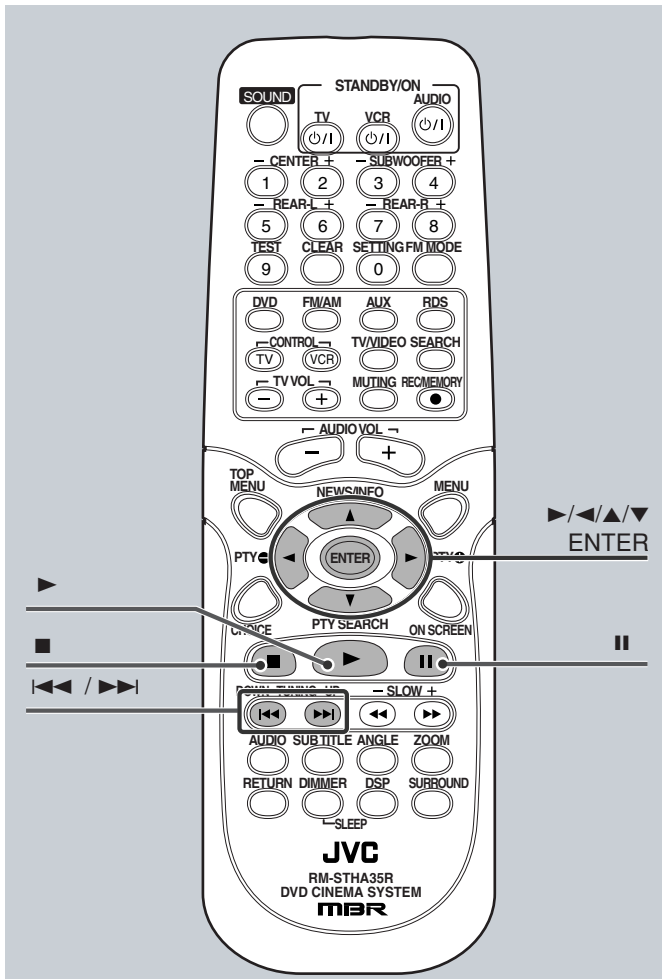

For in-depth information about a disc to be played back, see "Disc Introduction—DVD/VCD/CD" on page 22.

Starting Playback

It is recommended to turn on your TV when playing back an MP3 disc.

1 Insert an MP3 disc.

After detecting the disc, on-screen display appears on the TV.



2 Press cursor ►/◀/▲/▼ to select the track, then press ENTER.

Playback starts.

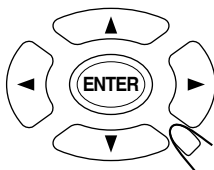

Note:

If the loaded disc is not recorded in the audio CD format, MP3 format, or JPEG format, "Error" appears on the TV screen.

The on-screen display

①: Track number
②: Current folder name
③: Current track (file) and total number of the tracks in the current folder • Ex.: 1st track is playing out of 28 tracks recorded.
④: Play mode
⑤: Elapsed playing time
⑥: Playback track (highlight)
⑦: File information • If the MP3 file has ID3v1 tag, file information appears.

To go to another track

Press ►► or ◀◀ during playback.

• ►► : Skip to the beginning of the next track.



• ◀◀ : Skip to the beginning of the previous track.



To stop playback for a moment

Press II.



To resume play, press ►.

To stop during playback

Press ■.



To start playback again

Press ►.

The marked (highlight) track starts playback.



To remove the disc

Press ▲ on the front panel.

The disc tray comes out.



To close the disc tray, press ▲ again.

MP3 Playback

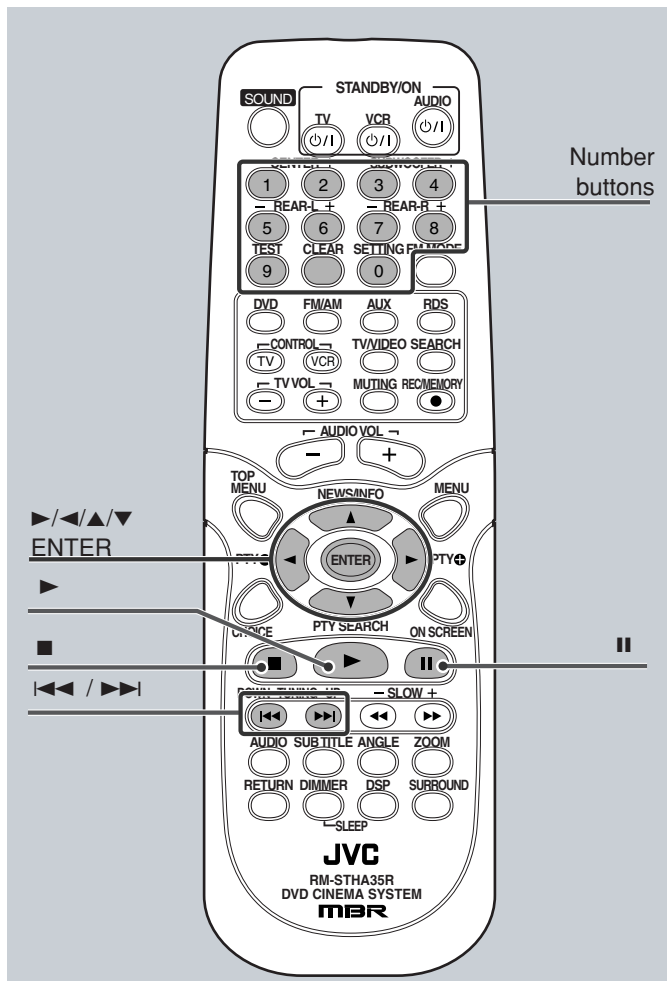

To start playback of the selected track

Press cursor \blacktriangleright / \blacktriangleleft / \blacktriangleup / \blacktriangledown to select the track, then press ENTER.

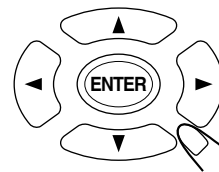

Notes:

- Only 10 tracks can be shown on the TV. To move to next 10 tracks, press cursor \blacktriangleright repeatedly. To move to previous 10 tracks, press cursor \blacktriangleleft repeatedly.
- If you move to another folder, playing back stops.

Moving to a Particular Track Directly

You can move to a particular track on the current folder directly.

From the remote control ONLY:

Press the number buttons to select a track number you want.

The system starts playback from the selected track.

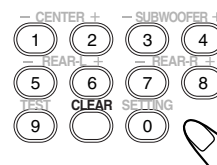

- To select number 5, press 5 then press ENTER.
- To select number 10, press 1, 0 then press ENTER.
- To select number 23, press 2, 3 then press ENTER.
- To select number 123, press 1, 2, 3 then press ENTER.

Operations Using the On-Screen Display

It is recommended to turn on your TV when playing back an MP3 disc.

When the loaded MP3 disc is recognized, the following on-screen display appears on the TV screen. (The contents of this on-screen display varies according to the disc—the way MP3 tracks were recorded on the disc.)

From the remote control ONLY:

Button	To do
ENTER	Start playback or go into a folder.
\blacktriangleright / \blacktriangleleft / \blacktriangleup / \blacktriangledown	Select a track or folder.

Programming the Playing Order of the Tracks — Program Play

You can arrange the track playback order before you start playing.

From the remote control ONLY:

1 Press cursor \blacktriangleright / \blacktriangleleft / \blacktriangleup / \blacktriangledown to select “Brow Disc,” then press ENTER.

“Brow Disc (Browse Disc)” changes to “Crea Prog (Create Program).”

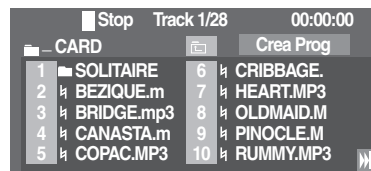
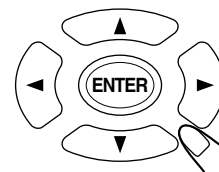

2 Press cursor \blacktriangleright / \blacktriangleleft / \blacktriangleup / \blacktriangledown to select the track.

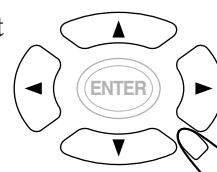
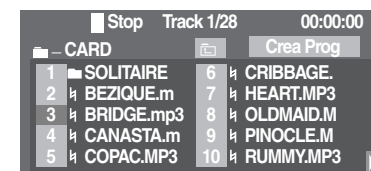

3 Press ENTER.

The selected track is marked (highlight).

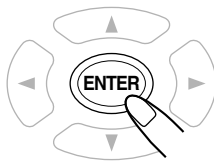
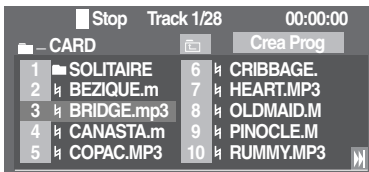

- If you press ENTER again, the marked track is canceled.

4 Repeat steps 2 to 3 to program other tracks you want.

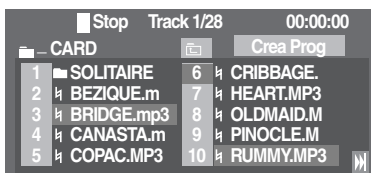

- You can select the track in another folders.
- You cannot select same track more than once during program play.

5 Press cursor >/</▲/▼ to select "Crea Prog," then press ENTER.

"Crea Prog (Create Program)" changes to "Brow Prog (Browse Program)," and selected tracks appear on the TV.

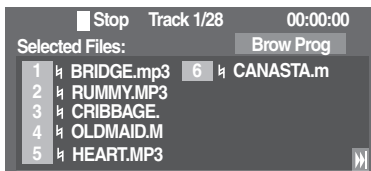
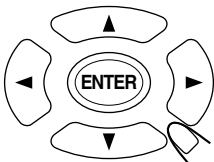

6 Press cursor >/</▲/▼ to select the start track, then press ENTER.

The tracks are played in the order you have programmed.

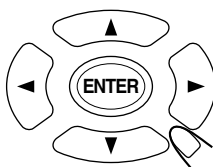

To exit from program play

From the remote control ONLY:

Press cursor >/</▲/▼ to select "Brow Prog," then press ENTER.

"Brow Prog (Browse Program)" changes to "Brow Disc (Browse disc)."

Playback stops and the stored program is cleared.

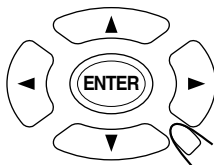

You can perform following operation same as in normal playback.

To go to another track

Press >>> or <<< during playback.

- >>> : Skip to the beginning of the next track.



- <<< : Skip to the beginning of the previous track.



To stop playback for a moment

Press II.



To resume play, press >.

To stop during playback

Press ■.



To start playback again

Press >.

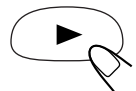

To start playback of the selected track

Press cursor >/</▲/▼ to select the track, then press ENTER.

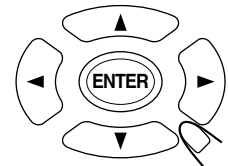

To move to a particular track directly

Press the number buttons to select a track number you want.

- To select number 5, press 5 then press ENTER.
- To select number 10, press 1, 0 then press ENTER.
- To select number 23, press 2, 3 then press ENTER.
- To select number 123, press 1, 2, 3 then press ENTER.

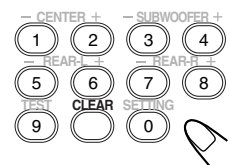

JPEG Playback

What is JPEG?

A still-picture data compression system proposed by the Joint Photographic Expert Group, which features small decrease in image quality in spite of its high compression ratio.

Disc structure

On a JPEG disc, each still picture (material) is recorded as a file. Files are usually grouped into a folder. Folders can also include another folders, creating hierarchical folder layers.

This system simplifies the hierarchical construction of a disc and manages folders by “groups.”

This system can recognize up to 999 items in one folder, items including subfolders and files.

- If there is any type of files other than JPEG files in a folder, those files are also counted in the total number of 999.

NOTES for JPEG disc

- JPEG discs (either CD-R or CD-RW) require a longer readout time. (It differs due to the complexity of the directory/file configuration.)
- When making a JPEG disc, select ISO 9660 Level 1 or Level 2 as the disc format.
- This system supports “multi-session” discs (up to 5 sessions).
- This system cannot play “packet write” discs.
- The system can play JPEG files only with the following file extensions: “.jpg,” “.jpeg,” “.JPG,” “.JPEG” and any uppercase and lowercase combination (such as “.Jpg”).
- We recommend to record a file at 640 x 480 resolution. (If a file has been recorded at a resolution of more than 640 x 480, it will take a longer time to be shown.)
- This system can play only baseline JPEG files*. Progressive JPEG files* or lossless JPEG files* cannot be played.
- Some JPEG discs may not be played back because of their disc characteristics or recording conditions.
- * • Baseline JPEG format: Used for digital cameras, web, etc.
- Progressive JPEG format: Used for web.
- Lossless JPEG format: An old type and rarely used now.

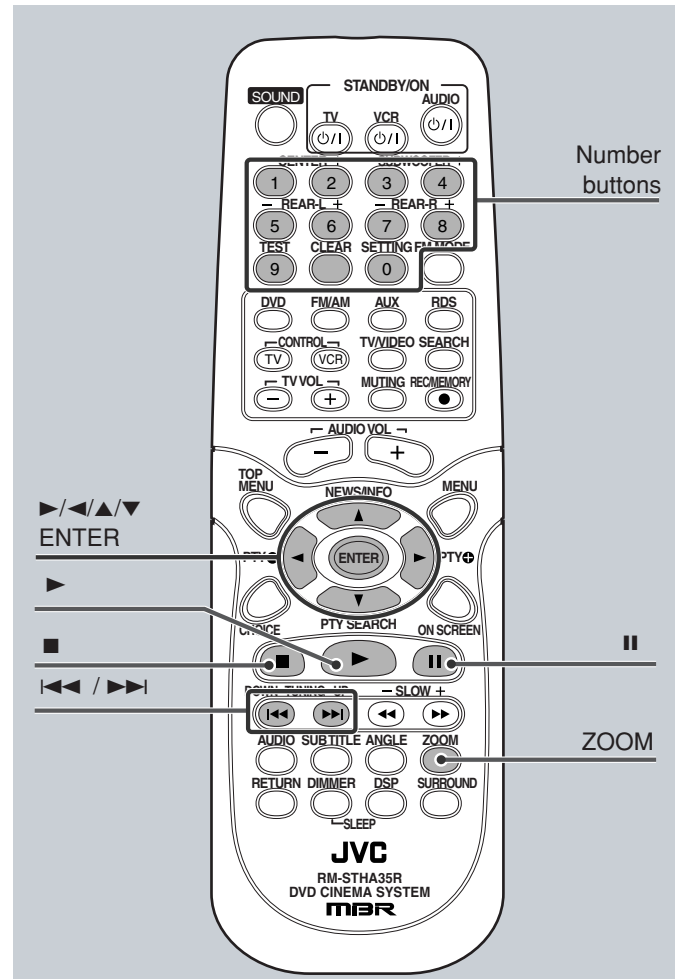

Loading the Disc

Insert a JPEG disc.

After detecting the disc, on-screen display appears on the TV.

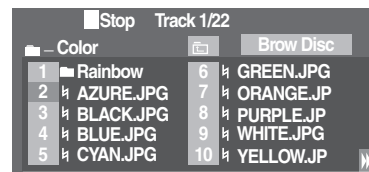

Operations Using the On-Screen Display

The on-screen display

①	File number
②	Current folder name
③	Current file and total number of the files in the current folder • Ex.: 1st file is playing out of 22 tracks recorded.
④	Play mode
⑤	Playback file (highlight) • When press ► to start playback slide-show, playback starts this (highlight) file.

From the remote control ONLY:

Button	To do
ENTER	Start playback or go into a folder.
► / ◀ / ▲ / ▼	Select a file or folder.

To select the file.

Press cursor ►/◀/▲/▼.

Note:

Only 10 files can be shown on the TV.
To move to next 10 files, press cursor ► repeatedly.
To move to previous 10 files, press cursor ◀ repeatedly.

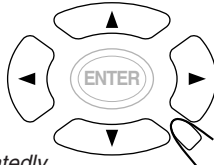

To show the selected file only

Press ENTER.

The selected file (still picture) is shown on the TV.

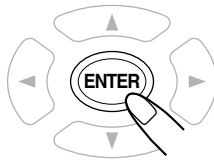

Notes

The picture size changes automatically to fit the TV-screen.

To start the slide-show playback

Press ►.

Each file (still picture) is shown on the TV for about few seconds, then changed to the next file one after another.



- The showing time varies depending on the file size or other factor.

To stop the slide-show playback temporarily

Press II on the remote control.



To resume the slide-show playback

Press ►.

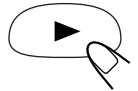

To stop the slide-show playback completely

Press ■.



To skip files forward

Press ►►.



To skip files backward

Press ◀◀.



To rotate a still picture

Press cursor ►/◀/▲/▼.

When the slide-show stops and the picture is rotated on the TV.

- : ANGLE 90
- ▼: ANGLE 180
- ◀: ANGLE 270
- ▲: ANGLE 0

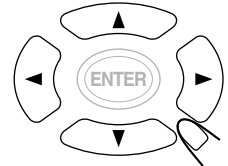

To return to normal angle, press the button again or press ▲.

To zoom in a still picture

Press ZOOM.

The zoom indicator appears on the TV.

- Each time you press the button while the indicator appears, the magnification changes as follows:

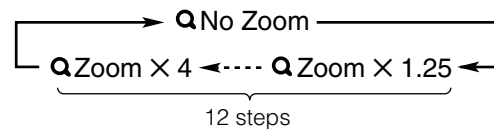

- While the picture is zoomed in, press cursor ►/◀/▲/▼ to move the portion you want to watch.

To cancel the zoom, press ►.

JPEG Playback

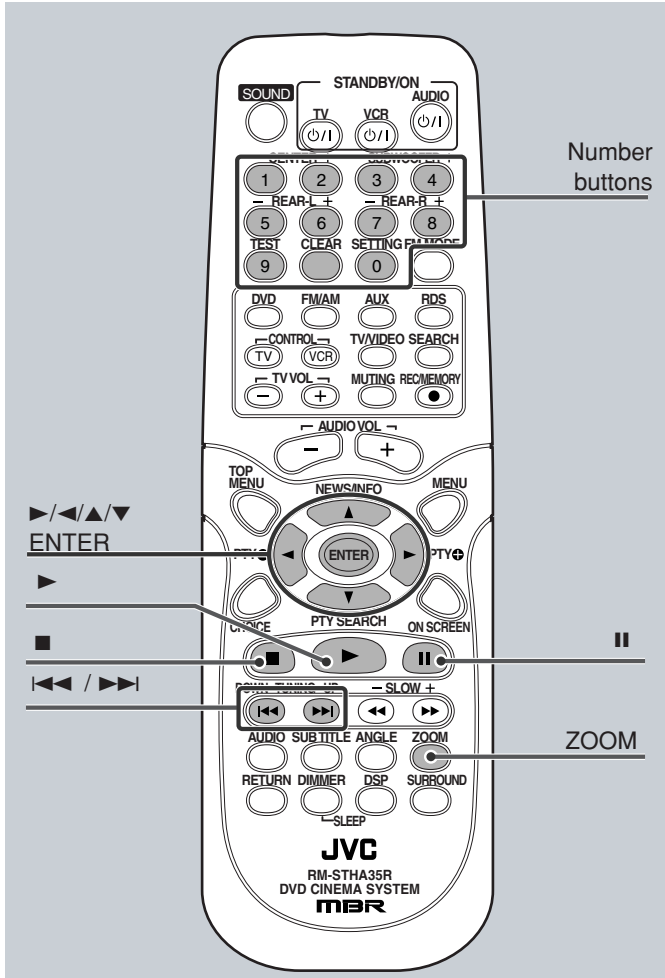

Moving to a Particular File Directly

You can move to a particular file on the current folder directly.

From the remote control ONLY:

Press the number buttons to select a file number you want.

The system starts playback from the selected file.

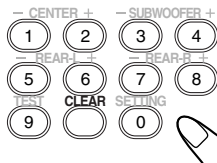

- To select number 5, press 5 then press ENTER.
- To select number 10, press 1, 0 then press ENTER.
- To select number 23, press 2, 3 then press ENTER.
- To select number 123, press 1, 2, 3 then press ENTER.

Programming the Playing Order of the Files — Program Play

You can arrange the file playback order before you start playing.

From the remote control ONLY:

1 Press cursor $\blacktriangleright/\blacktriangleleft/\blacktriangleup/\blacktriangledown$ to select “Brow Disc,” then press **ENTER**.

“Brow Disc (Browse Disc)” changes to “Crea Prog (Create Program).”

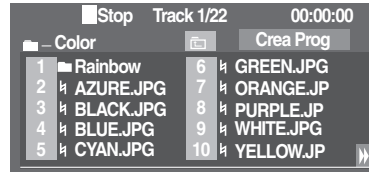
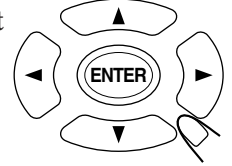

2 Press cursor $\blacktriangleright/\blacktriangleleft/\blacktriangleup/\blacktriangledown$ to select the file.

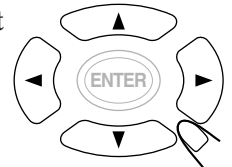
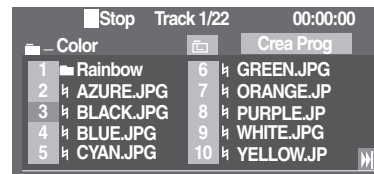

3 Press **ENTER**.

The selected file is marked (highlight).

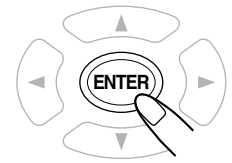
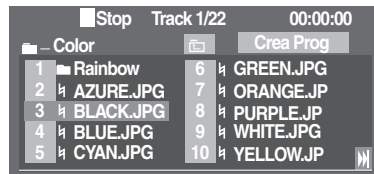

- If you press ENTER again, the marked file is canceled.

4 Repeat steps 2 to 3 to program other files you want.

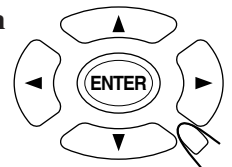

- You can select the files in another folders.
- You cannot select same file more than once during program play.

5 Press cursor ►/◄/▲/▼ to select “Crea Prog,” then press ENTER.

“Crea Prog (Create Program)” changes to “Brow Prog (Browse Program),” and selected files appear on the TV.

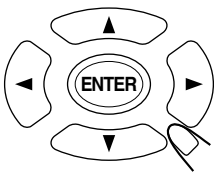
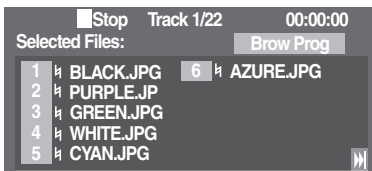

6 Press cursor ►/◄/▲/▼ to select the start file.

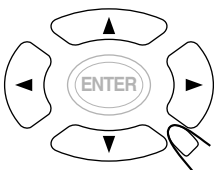

7 Press ► or ENTER.

The selected files are played in the order you have programmed.

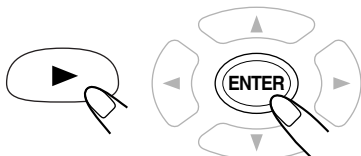

To exit from program play

From the remote control ONLY:

Press cursor ►/◄/▲/▼ to select “Brow Prog,” then press ENTER.

“Brow Prog (Browse Program)” changes to “Brow Disc (Browse disc).”

Playback stops and the stored program is cleared.

You can perform following operation same as in normal playback.

To go to another file

Press ►► or ◄◄ during playback.

- ►► : Skip to the beginning of the next file.



- ◄◄ : Skip to the beginning of the previous file.



To stop playback for a moment

Press II.



To resume play, press ►.

To stop during playback

Press ■.



To start playback again

Press ►.



To rotate a still picture

Press cursor ►/◄/▲/▼.

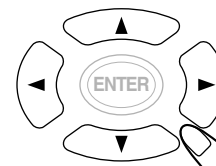

To zoom in a still picture

Press ZOOM.



To start playback of the selected file

Press cursor ►/◄/▲/▼ to select the file, then press ENTER.

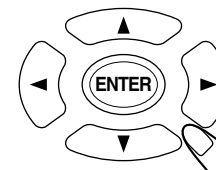

To move to a particular track directly

Press the number buttons to select a file number you want.

- To select number 5, press 5 then press ENTER.
- To select number 10, press 1, 0 then press ENTER.
- To select number 23, press 2, 3 then press ENTER.
- To select number 123, press 1, 2, 3 then press ENTER.

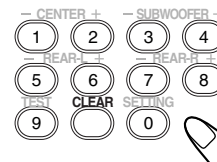

Tuner Operations

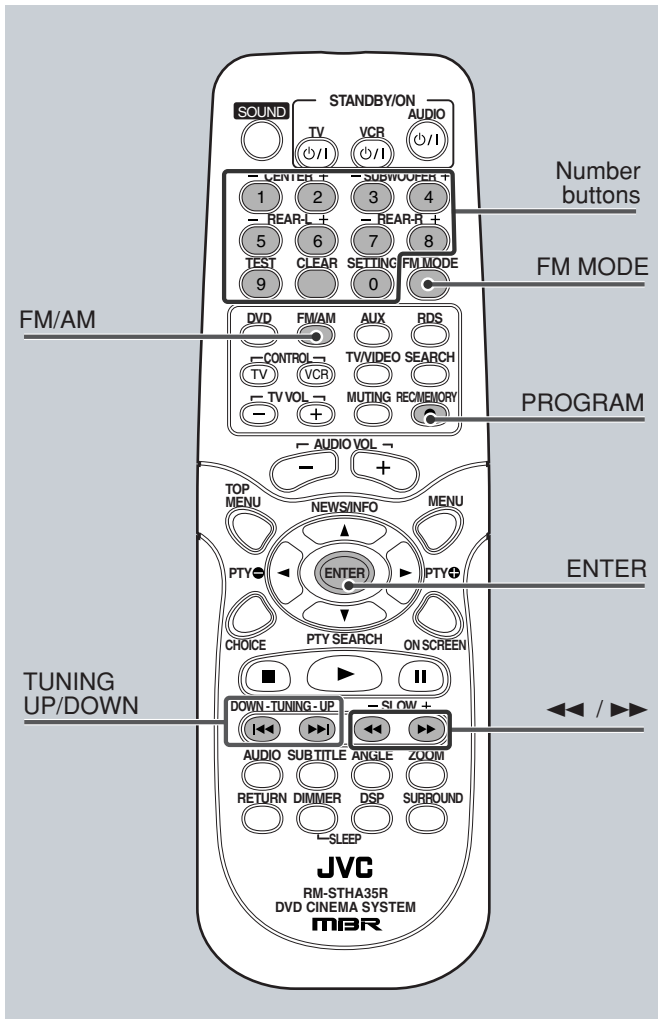

For basic tuner operations, see "Basic Tuner Operations" on page 14.

Tuning in Stations

From the remote control:

1 Press FM/AM repeatedly to select the band.

The last received station of the selected band is tuned in.

- Each time you press the button, the band alternates between FM and AM.



2 Press and hold TUNING UP or DOWN until you find the frequency you want.

- TUNING UP : Increases the frequency.
- TUNING DOWN : Decreases the frequency.



The system starts searching for stations and stops when a station of sufficient signal strength is tuned in.

- You can use the number button to enter the station frequency directly

On the front panel:

1 Press SOURCE repeatedly until the desired band appears on the display.

The last received station of the selected band is tuned in.

- Each time you press the button, the source changes as follows:

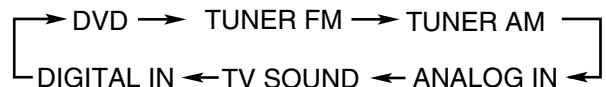

2 Press and hold >>> or <<< until you find the frequency you want.

- >>> : Increases the frequency.
- <<< : Decreases the frequency.



The system starts searching for stations and stops when a station of sufficient signal strength is tuned in.

Notes:

- When a station of sufficient signal strength is tuned in, the TUNED indicator lights up on the display.
- When an FM stereo program is received, the STEREO indicator also lights up.
- When you press the button repeatedly, the frequency changes step by step.

Using Preset Tuning

Once a station is assigned to a channel number, the station can be quickly tuned. You can preset up to 30 FM and 15 AM stations.

To store the preset stations automatically

From the remote control ONLY:

Press and hold MEMORY for a while.

“AUTO SAVE” appears on the display, and automatic preset starts.

Local stations with the strong signals are searched for and stored automatically in the band. When FM preset is over, the band changes to AM and automatic preset starts.



To store the preset stations

From the remote control ONLY:

1 Tune in the station you want to preset (see “Tuning in Stations”).



2 Press MEMORY.

“SAVE TO” appears on the display.



3 Press the number button to select a preset number.

- To select number 1 to 9, press the corresponding number button.
- To select number 15, press 1, 5.
- To cancel a mis-entry, press CLEAR.

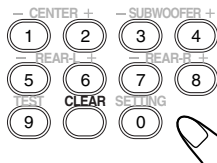

4 Press ENTER to store the preset station.

“SAVED” appears on the display and the station is assigned to the selected preset number.

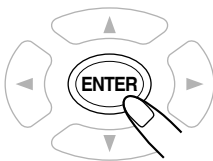

5 Repeat steps 1 to 4 until you store all the stations you want.

To erase a stored preset station

Storing a new station on a used number erases the previously stored one.

To tune in a preset station

From the remote control ONLY:

1 Press FM/AM repeatedly to select the band.

The last received station of the selected band is tuned in.

- Each time you press the button, the band alternates between FM and AM.



2 Press the number button to select a preset station.

- To select number 1 to 9, press the corresponding number button, then press ENTER.
- To select number 15, press 1, 5 then press ENTER.
- To cancel a mis-entry, press CLEAR.

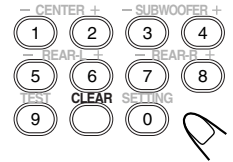

- You can press >>>/<<< to select the preset station.

- >>>: Increases the preset number.
- <<<: Decreases the preset number.

Selecting the FM Reception Mode

When an stereo FM program tuned currently is noisy, you can change the FM reception mode to improve the reception.

From the remote control ONLY:

Press FM MODE.

The STEREO indicator goes off from the display and the program loses the stereo effect.



To resume the stereo effect, press FM MODE again. The stereo effect resumes.



Note:

- The FM reception mode will also resumes in the following cases:
- When you change the frequency, the preset number, or the band
 - When you change the source (If you use SOURCE button on the unit, the FM reception mode is memoried.)
 - When you turn off the system

Tuner Operations

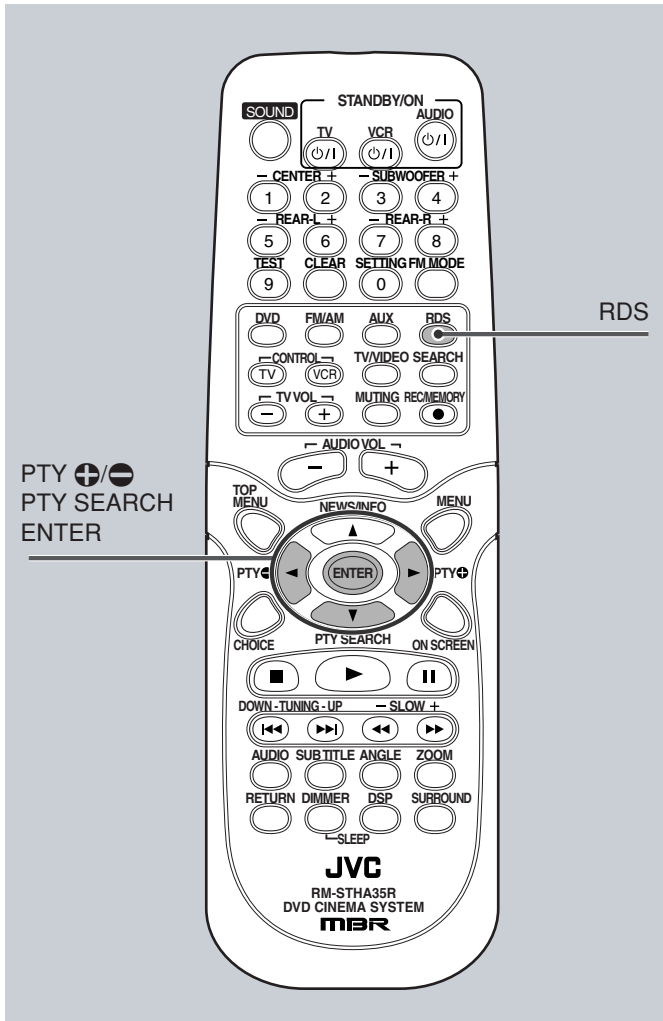

PTY \oplus/\ominus
PTY SEARCH
ENTER

RDS

What information can RDS signals provide?

You can see the following RDS signals the station sends on the display.

PS NAME:

While searching, "PS NAME" appears, then the station names will be displayed. Station frequency appears if no signal is sent.

Frequency:

Station frequency.

PROG TYPE (Program Type):

While searching, "PROG TYPE" appears, then the current PTY code appears. "NO PTY" appears if no signal is sent.

RADIO TEXT:

While searching, "RADIO TEXT" appears, then text messages the station sends will be displayed. "NO RT" appears if no signal is sent.

From the remote control ONLY:

Make sure that the remote control is for the tuner operation. If not, press FM/AM on the remote control so that the remote control can be used for the tuner operation.

Press RDS while listening to an FM station to show the RDS signals.

- Each time you press the button, the display changes to show the following information:

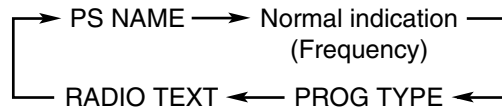

About characters shown on the display

When the display shows PS NAME, or RT signals, the following characters are used.

- The display cannot differentiate upper case and lower case letters and always uses upper case letters.
- The display cannot show accented letters, "A" for instance, may stand for accented "A" like "Å, Ä, Æ, Á, À, Â, â, ä, ã, á, à, and â."

Note:

If searching finishes at once, "PS NAME," "RADIO TEXT," and "PROG TYPE" will not appear on the display.

If the remote control is not for the tuner operations, the button for the RDS operations—NEWS/INFO, PTY + and -, and PTY SEARCH—do not work. In this case, press FM/AM on the remote control so that the remote control can be used for the tuner operation.

Using the RDS (Radio Data System) to Receive FM Stations

RDS allows FM stations to send an additional signal along with their regular program signals. For example, the stations send their station names, as well as information about what type of program they broadcast, such as sports or music, etc.

When tuned to an FM station which provides the RDS service, the RDS indicator lights up on the display.

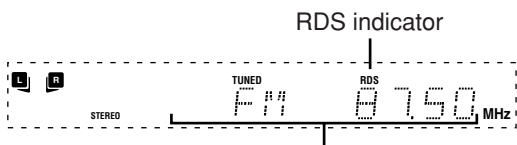

Then, the display shows its PS name.

Notes:

- RDS is not available for AM broadcasts.
- RDS may not operate correctly if the tuned station is not transmitting RDS signals properly or if the signal strength is weak.

Searching for a Program by PTY Codes

One of the advantages of the RDS service is that you can locate a particular kind of program from the preset channels (see page 47) by specifying the PTY codes.

To search for a program using the PTY codes

Before you start, remember...

- The PTY Search is only applicable to preset stations.
- There is a time limit in doing the following steps. If the setting is canceled before you finish, start from step 1 again.

From the remote control ONLY:

Make sure that the remote control is for the tuner operation. If not, press FM/AM on the remote control so that the remote control can be used for the tuner operation.

1 Press PTY SEARCH while listening to an FM station.

“PTY SEARCH” appears on the display.



2 Press PTY + or PTY - until the PTY code you want appears on the display.

• For details, see “Description of the PTY codes” on page 51.

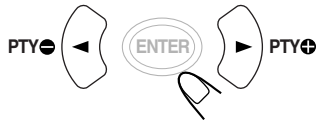

3 Press ENTER, while the PTY code selected in the previous step is still on the display.

The system searches FM preset stations, stops when it finds the one you have selected, “FOUND” appears on the display and tunes in that station.

- If no program is found, “NOT FOUND” appears on the display.

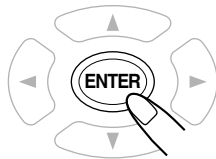

To stop during searching

Press PTY SEARCH again.

“SEARCH OFF” appears on the display.



PTY codes



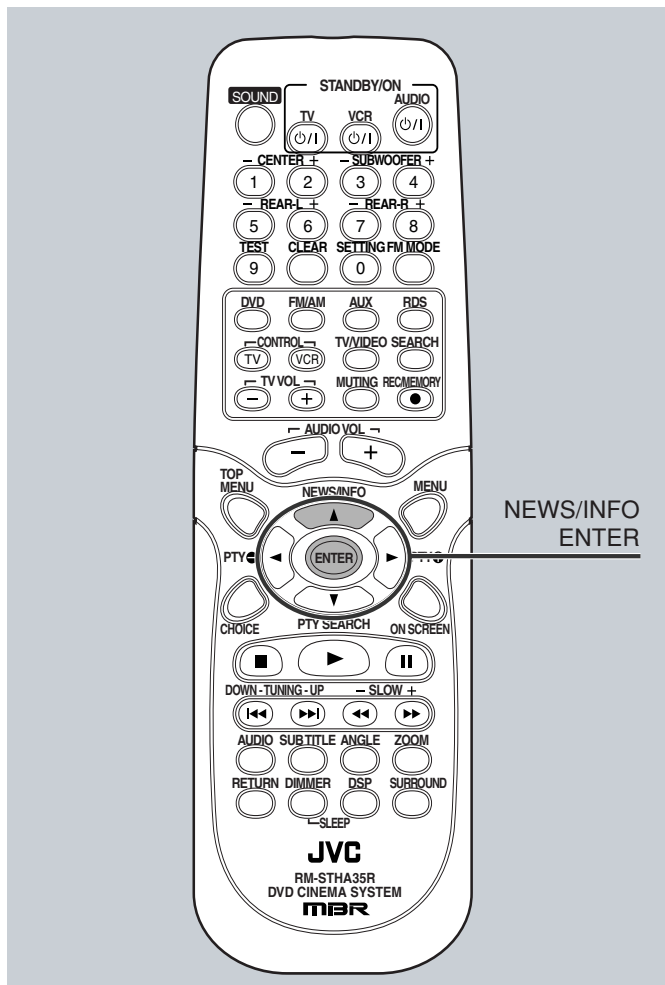

Switching to a Selected Program

You can locate a particular kind of program from an FM RDS station.

From the remote control ONLY:

Make sure that the remote control is for the tuner operation. If not, press FM/AM on the remote control so that the remote control can be used for the tuner operation.

1 Press NEWS/INFO.

- Each time you press the button, the display changes to show the following.

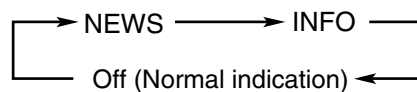

-
- NEWS:** News.
-
- INFO:** Program the purpose of which is to impart advice in the widest sense.
-
- Off:** The search function is canceled.
-

2 Press ENTER

The system searches FM stations, stops when it finds the one you have selected, "FOUND" appears on the display and tunes in that station.

- If no program is found, "NOT FOUND" appears on the display.



■ **Description of the PTY codes:**

NEWS:	News.	FINANCE:	Stock Market reports, commerce, trading etc.
AFFAIRS:	Topical program expanding or enlarging upon the news—debate, or analysis.	CHILDREN:	Programs targeted at a young audience.
INFO:	Programs the purpose of which is to impart advice in the widest sense.	SOCIAL:	Programs about sociology, history, geography, psychology and society.
SPORT:	Programs concerned with any aspect of sports.	RELIGION:	Religious programs.
EDUCATE:	Educational programs.	PHONE IN:	Involving members of the public expressing their views either by phone or at a public forum.
DRAMA:	All radio plays and serials.	TRAVEL:	Travel information.
CULTURE:	Programs concerning any aspect of national or regional culture, including language, theater, etc.	LEISURE:	Programs about recreational activities.
SCIENCE:	Programs about natural sciences and technology.	JAZZ:	Jazz music.
VARIED:	Used for mainly speech-based programs such as quizzes, panel games and personality interviews.	COUNTRY:	Songs which originate from, or continue the musical tradition of the American Southern States.
POP M:	Commercial music of current popular appeal.	NATION M:	Current popular music of the nation or region in that country's language.
ROCK M:	Rock music.	OLDIES:	Music from the so-called "golden age" of popular music.
EASY M:	Current contemporary music considered to be "easy-listening."	FOLK M:	Music which has its roots in the musical culture of a particular nation.
LIGHT M:	Instrumental music, and vocal or choral works.	DOCUMENT:	Programs concerning factual matters, presented in an investigative style.
CLASSICS:	Performances of major orchestral works, symphonies, chamber music, etc.	TEST:	Broadcasts for testing emergency broadcast equipment or unit.
OTHER M:	Music not fitting into any of the other categories.	ALARM:	Emergency announcement.
WEATHER:	Weather reports and forecasts.		

Classification of the PTY codes for some FM stations may be different from the above list.

Setting up the DVD Preferences

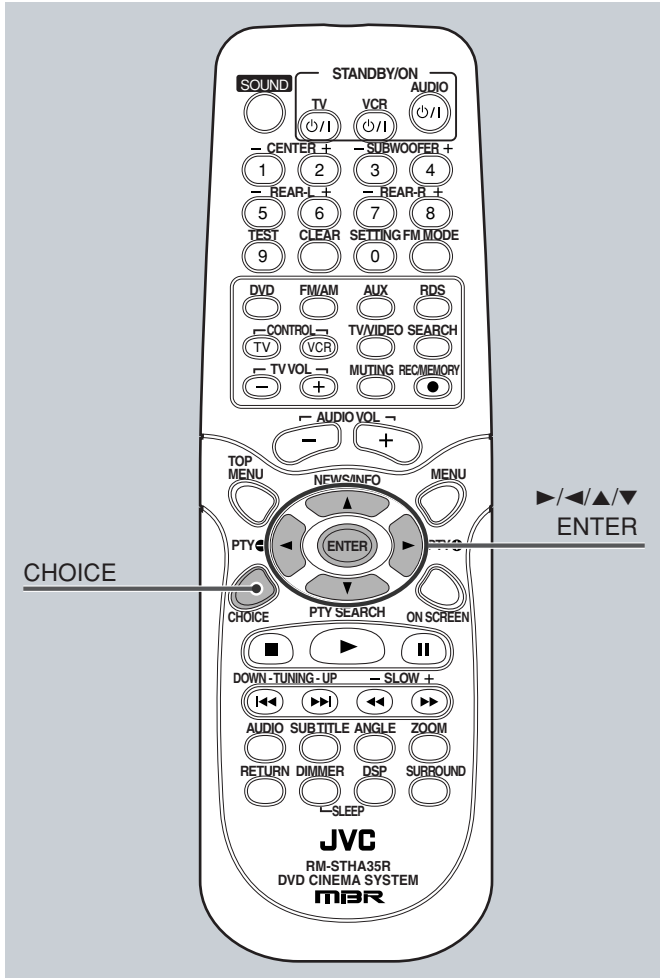

Using the Choice Menus

You can adjust the initial setting of DVD playback according to your preference or needs through five choice menus.

- You need to turn on your TV and select the correct input mode on the TV.
- You can select the choice menu only when DVD is selected as the source and playback stops.
- You can only use the remote control for the choice menu operations.
- You can change the language used in the choice menus. See page 53.

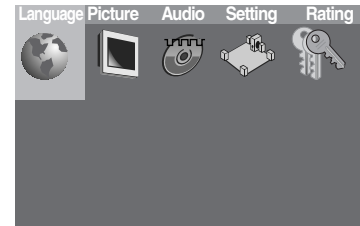

Language: You can select the initial languages for the disc menu, audio, and subtitle. You can also select the language used on the TV screen while operating this system.

Picture: You can select the desired options concerning a picture or monitor screen.

Audio: The Audio menu is not used for this system.

Setting: You can make the speaker settings according to the layout of your speakers.

Rating: You can change the setting the parental lock. See "Setting the Parental (Rating) Level" on page 57.

Basic procedure through the choice menus

1 Press CHOICE.

The choice menu appears on the TV.

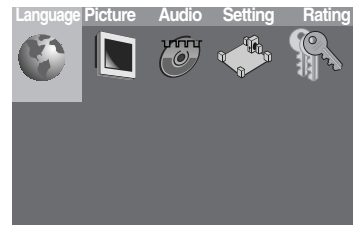

2 Press cursor ►/◀ repeatedly to select one of the choice menus—Language, Picture, Audio, Setting, or Rating.

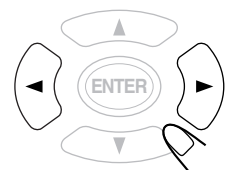

3 Press ENTER

The selected menu appears on the TV.

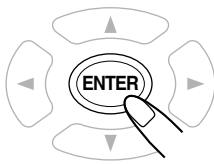
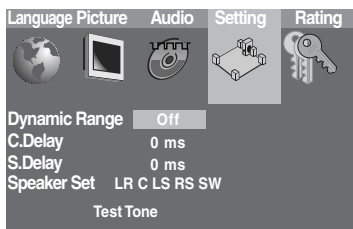

Example: When the Setting menu is selected.

4 Press cursor ▲/▼ repeatedly to select the item you want to set up.

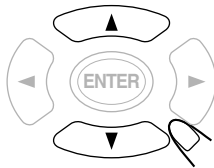

5 Press ENTER

- Each time you press the button, the setting of the item changes.

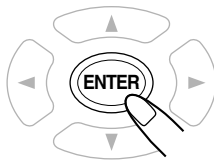
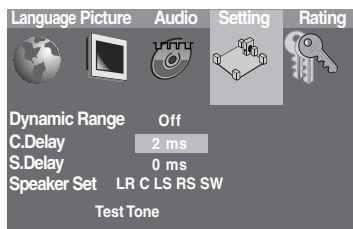

Example: When the C.Delay is selected.

Notes:

- Some choice menus consist of two pages. Selecting "Next Page" and pressing ENTER makes its next menu appear on the TV.
- Some items in the choice menus consist of sub-menus to set up. Selecting them and pressing ENTER makes its sub-menu appear on the TV. You can set them using cursor ▲/▼ and ENTER (as explained in this basic procedure). To return from the sub-menu, cursor ◀.

To move to another choice menu

Press cursor ▲ when the top of the items in the menu is selected.

Language Menu

You can select your favorite language you listen to or read on the TV screen.

When you operate this system or watch a DVD, you will be able to operate the system or to enjoy a DVD in the language you have selected and stored.

On the Language menu, you can select the following:

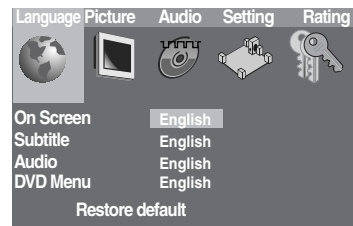

On Screen:	Select the indication language shown on the TV screen while operating the system. (ex. PLAY, STOP, PAUSE, etc.)
Subtitle:	Select the subtitle language you read while watching a DVD.
Audio:	Select the language you listen to while watching a DVD.
DVD Menu:	Select the menu language recorded on a DVD which you use while operating the DVD's own menu.
Restore default:	All choice menu settings (except for "Interlace" setting in the Picture menu, Rating level and the password in the Rating menu) return to initial setting. If you select this item and press ENTER, "System Reset" appears on the TV. To reset the settings, select "OK" and press ENTER. All choice menu settings return to initial setting, the choice menu disappears and the disc is loaded again.

Languages you can select on this menu

You can select the following languages separately for each listed item on the menu.

- For "On screen," "Audio," and "DVD Menu": English, French, and German.
- For "Subtitle": English, French, German, Auto and Off.

Note:

The original language will be selected as the initial language regardless of your setting in the following cases:

- If the language you have selected is not recorded on the disc.
- If the disc is programmed to be played back in the original language.

Setting up the DVD Preferences

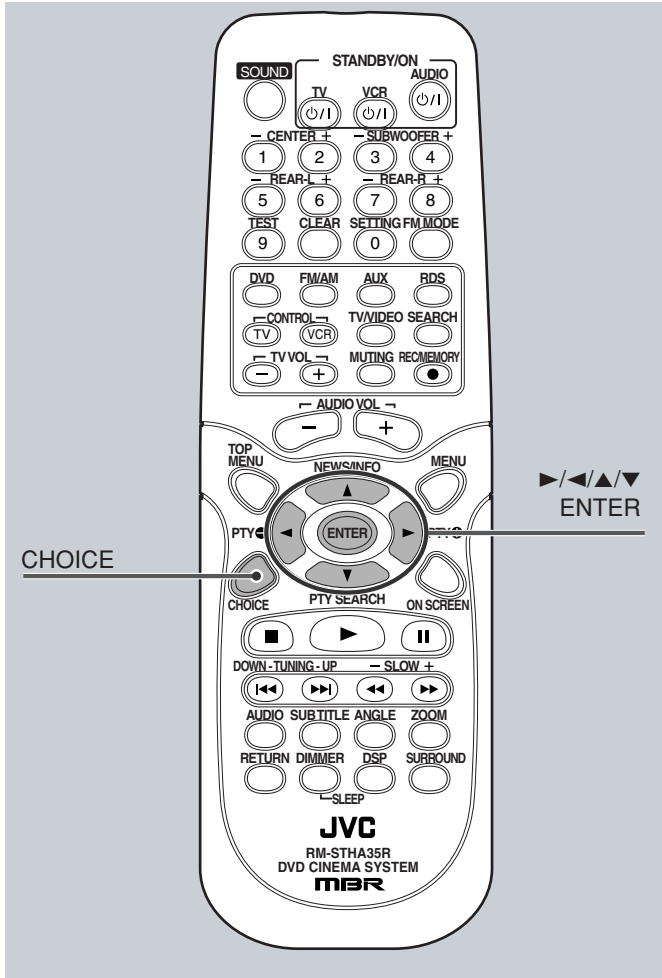



Picture Menu

You can select the desired options concerning a picture or monitor screen.

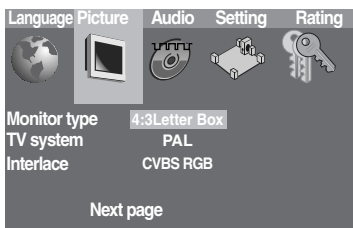
On the Picture menu, you can set the following:

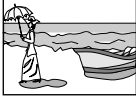

Monitor Type: Select the TV screen size for playing back a DVD recorded with 16:9 wide screen video signal.

- **4:3 Letter Box:** Select “4:3 Letter Box” when the aspect ratio of your TV is 4:3. While viewing a wide screen picture, the black bars appear on the top and the bottom of the screen. 
- **4:3 Pan-Scan:** Select “4:3 Pan-Scan” when the aspect ratio of your TV is 4:3. While viewing a wide screen picture, the black bars do not appear, however, the left and right edge sides of the pictures will not be shown on the screen. 
- **16:9 Wide:** Select “16:9 Wide” when the aspect ratio of the TV is 16:9. (Set the screen size to full on your TV.) 

TV System: You cannot select this item.

Interlace: Select the video signal type.

- **CVBS S_Video:** Select this when you use the S-Video cord to connect a TV.
- **CVBS RGB:** Select this when you do not use the S-Video cord to connect a TV.

TE Mode: You can select the TE (Transition Effect) mode.

- **On:** When the picture changes and appears on the TV, the picture appears with transition effect.
- **Off:** The picture appears without effect.

Pause/Still: You can change this mode to get better pictures when the picture is unclear or noisy. Normally select “AUTO.” If the picture on a disc is unclear or noisy, select “Frame” or “Field.”

- **Frame:** Select this when the small text or fine patterns cannot be seen clearly.
- **Field:** Select this when the moving picture is noisy.
- **Auto:** Normally select this mode. The system selects the appropriate mode automatically.

Audio Menu

The Audio menu is not used for this system.

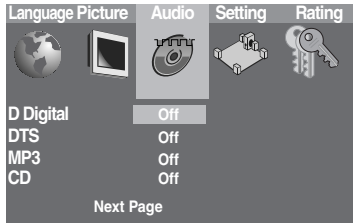

D Digital / DTS / MP3 / CD / PCM / DownSampling :
• Off

Setting Menu

You can make the speaker settings according to the size and layout of your speakers.

On the Setting menu, you can set the following:

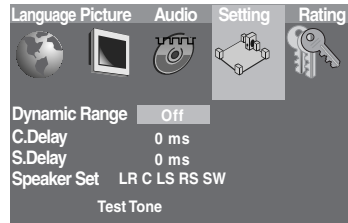

Dynamic Range: You can enjoy a powerful sound at night even at a low volume level when listening to the sound with Dolby Digital.

- **On:** Select this when you want to apply the compression effect fully (useful at midnight.)
- **Off:** Select this when you want to enjoy surround with its full dynamic range (no effect applied.)

C.Delay: To register delay time for center speaker—from 0 msec to 5 msec. See “Setting the delay time” on the next page.

R.Delay: To register delay time for rear speakers—from 0 msec to 15 msec. See “Setting the delay time” on the next page.

Speaker Set: Enters Speaker setting sub-menu. See “Speaker setting” on the next page.

Test Tone: The test tone menu appears on the TV and the test tone comes out from the speakers in the order. See “Adjusting the Sound” on page 21.

- If a disc is not loaded, the test tone does not come out.
- If there is a speaker from which no sounds comes out, check the speaker’s connection (see pages 6 and 7.)

TO BE CONTINUED ON THE NEXT PAGE

Setting up the DVD Preferences

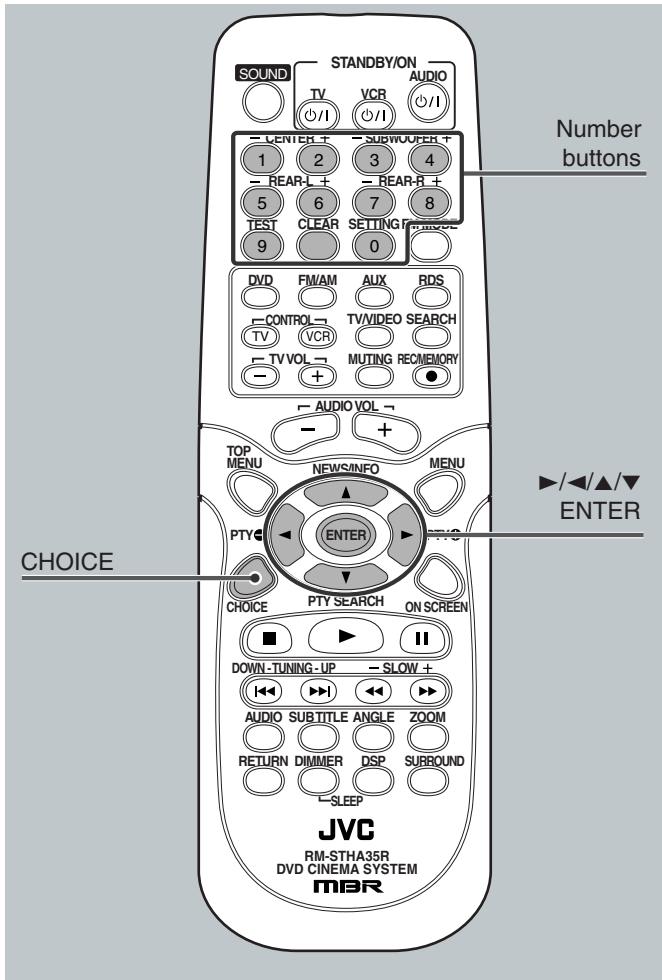

■ Setting the delay time

Adjust the delay time of the sounds from the center speaker and the rear speakers, comparing to that of the sounds from the front speakers. If the distance to the center speaker and/or the rear speakers from your listening point is almost the same as from the front speakers, select "0 ms (msec)."

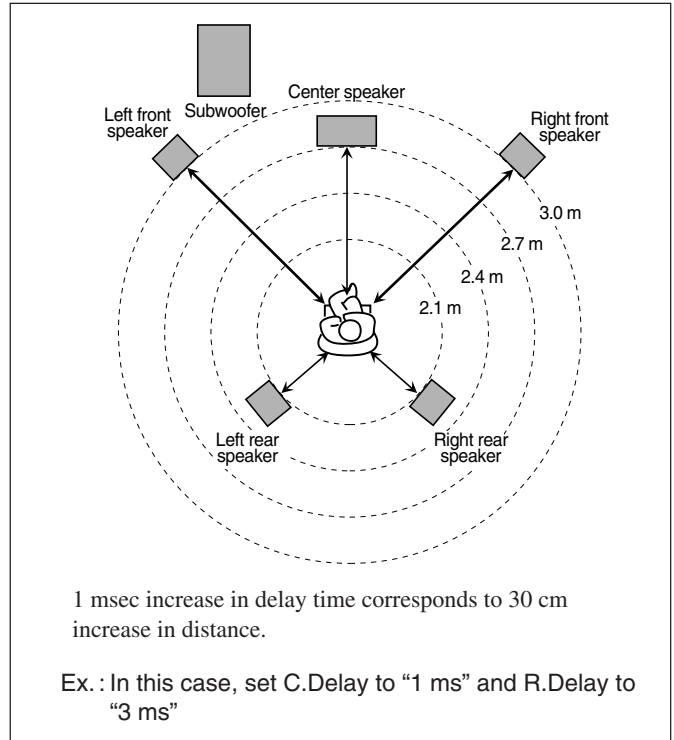

■ Speaker setting

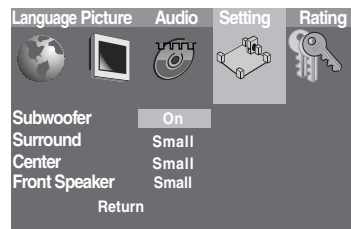

Subwoofer: You cannot select this item.

Surround / Center / Front Speaker:

Select the speaker setting according to the layout of your speakers. (You cannot select "Off" for the front speakers.)

- **Small:** Select this when the cone speaker unit built in the speaker is smaller than 12 cm. (Select this when using the supplied speakers.)
- **Off:** Select this when the center speaker and/or rear speakers are not connected or not in use. If you want to enjoy monaural source with the front speakers, select "Off" for the center speaker.

Return: Return to the Setting menu.

Setting the Parental (Rating) Level

Using this function, you can restrict playback of DVD containing violent scenes and those not suitable for your family members. Nobody can play such a disc unless this function is canceled (See "To release the parental lock temporarily" below.)

- This setting takes effect only for the DVDs containing the rating level information—"1. Kid Safe" (most restrictive) to "8. Adult" (least restrictive).

From the remote control ONLY:

1 Press CHOICE.

The choice menu appears on the TV.



2 Press cursor ► repeatedly to select "Rating."

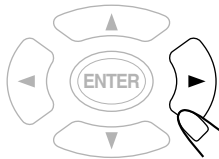

3 Press ENTER.

The Rating menu appears on the TV.

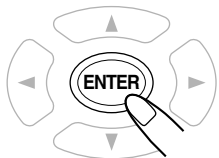
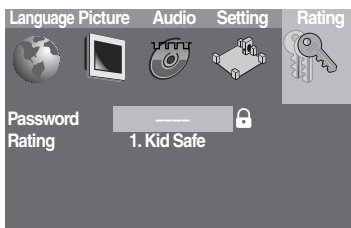

4 Press the number buttons to enter the password (4 digits), then ENTER.

"🔒" changes to "🔓" on the menu.

- If you forget your password, enter "1987"

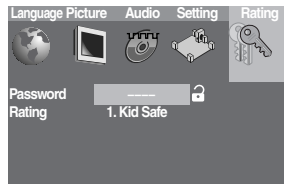
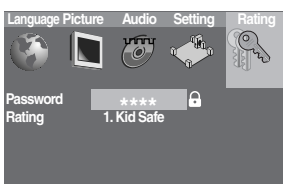
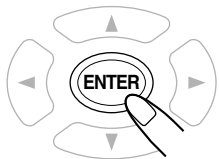
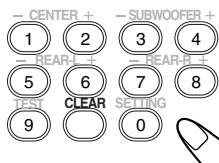

5 Press cursor ▼ to select "Rating."

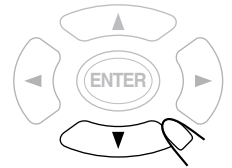
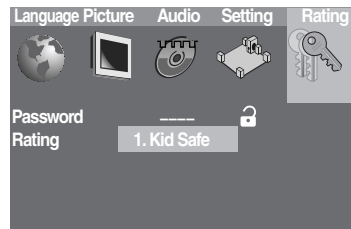

- If you do not release the parental lock ("🔒" appears on the TV), cannot select "Rating."

6 Press ENTER repeatedly to select the level you want.

- Each time you press the button, the parental (rating) level changes.

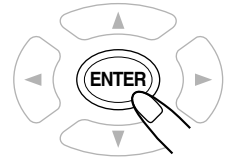

7 Press cursor ▲ to select "Password", then press the number buttons to enter the password (4 digits) and ENTER.

- "🔒" changes to "🔓" on the menu, and the parental level changes.

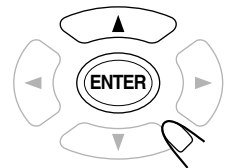
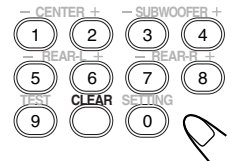

■ To change the password

1 Repeat steps 1 to 4 of "Setting the Parental (Rating) Level" procedure.

2 Press the number buttons to enter a new password (4 digits), then ENTER.

- "🔒" changes to "🔓" on the menu. Your new password is now stored.

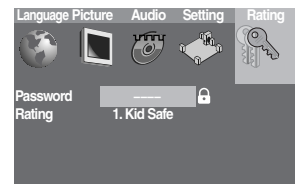
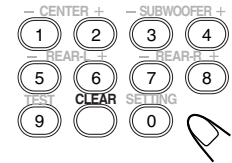

■ To release the parental lock temporarily

When you set a strict parental level, some discs may not be played back at all.

If you try to playback such a disc, you need to input the password to release parental lock temporarily ("Password ----" and "Parental Locked" appear on the TV.) You cannot play the disc before you enter the correct password.

When you enter wrong passwords more than three times, "Parental Lock" appears on the TV and playback stops.

Operating JVC's Components

You can use the remote control to operate not only this unit but also other JVC products.

- Refer also to the manuals supplied for the other products.
 - This remote control can operate a VCR whose remote control code is set to A code.
- To operate the other products, aim the remote control directly at the remote sensor on the target product.

□ To operate a JVC's TV

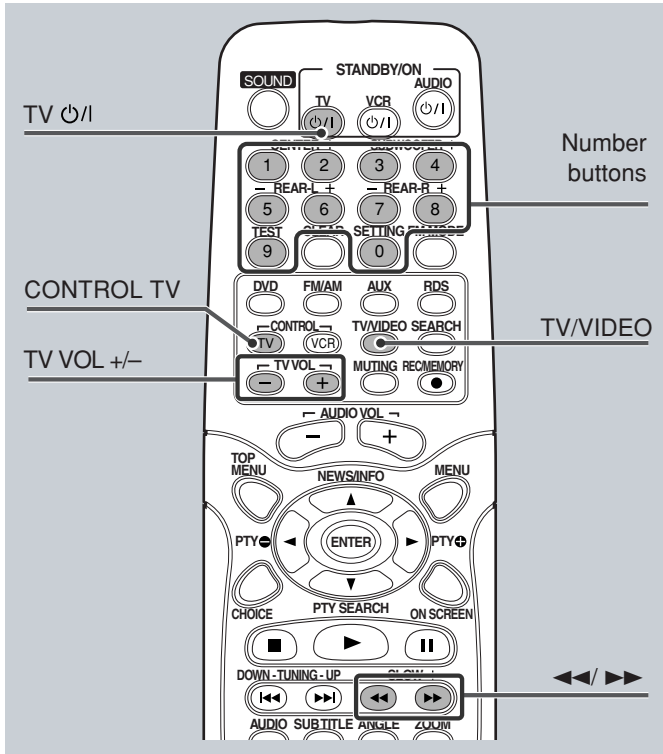

After pressing **CONTROL TV** on the remote control, you can perform the following operations on the TV.



TV \odot/I:	Turn on or off the TV.
TV VOL +/-:	Adjust the volume.
TV/VIDEO:	Set the input mode (either TV or VIDEO).
1 – 9, 0:	Select the channel.
\leftarrow/\rightarrow:	Change the channels.

□ To operate a JVC's VCR

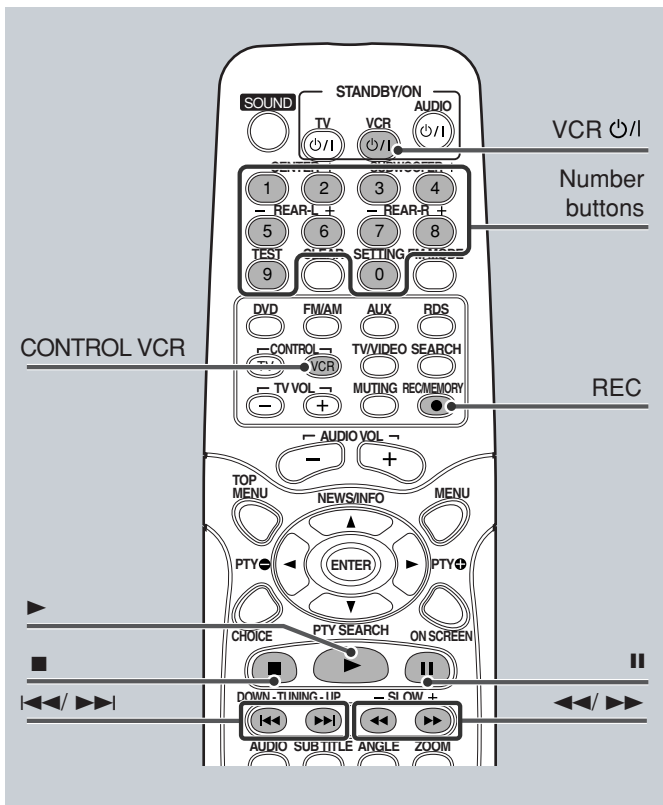

After pressing **CONTROL VCR** on the remote control, you can perform the following operations on the VCR.



VCR \odot/I:	Turn on or off the VCR.
\leftarrow/\rightarrow:	Change the channels.
1 – 9, 0:	Select TV channel on the VCR.
\blacktriangleright:	Start playback.
\blacksquare:	Stop operation.
II:	Pause playback. To release it, press \blacktriangleright .
REC(\bullet):	Press this button with \blacktriangleright to start recording. Press this button and II , to enter recording pause. To release it, Press II .
$\blacktriangleright\blacktriangleright$:	Fast-wind a tape.
$\blacktriangleleft\blacktriangleleft$:	Rewind a tape.

IMPORTANT:

When you press **CONTROL TV** or **CONTROL VCR**, some buttons on the remote control cannot work for operating the system.

To operate the system, press **DVD**, **FM/AM** or **AUX**.

Operating Other Manufacturers' TV

You can use the remote control to operate other manufacturers' TV.

- Refer also to the manuals supplied for the other products.
- To operate the other products, aim the remote control directly at the remote sensor on the target product.

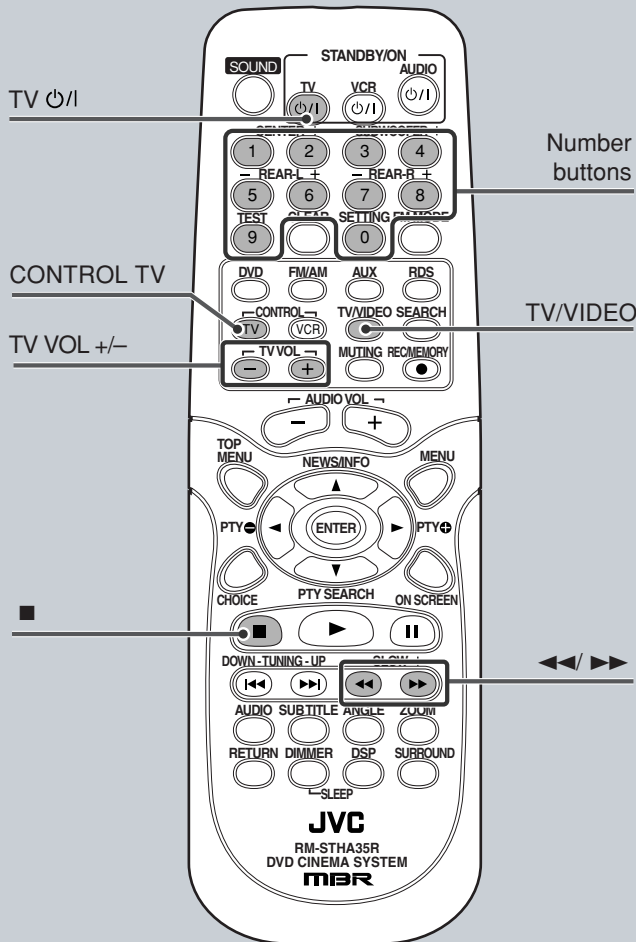

□ To change the transmittable signals for operating a TV

1. Press **CONTROL TV**.
2. Press and hold **TV $\odot/\!/\!$** .
3. Enter manufacturer's code using buttons **1-9**, and **0**.
4. Press **■**.
5. Release **TV $\odot/\!/\!$** .

Now, you can perform the following operations on the TV.

TV $\odot/\!/\!$:	Turn on or off the TV.
TV VOL +/- :	Adjust the volume.
TV/VIDEO :	Set the input mode (either TV or VIDEO)
1 - 9, 0 :	Select the channel.
◀▶ :	Change the channels.

6. Try to operate your TV by pressing **TV $\odot/\!/\!$** .
When your TV turns on or off, you have entered the correct code.

If there are more than one code listed for your brand of TV, try each one until the correct one is entered.

Manufacturers' codes for TV

Manufacturer	Codes
JVC	01, 23, 24, 25
FUNAI	32
GRUNDIG	19
HITACHI	10
LG (GOLDSTAR)	18
MAGNAVOX	02
MITSUBISHI	03
NEC	20
NOKIA	31
PANASONIC	04, 11
PHILIPS	02
RCA	05
SAMSUNG	12, 33, 34, 35
SANYO	13, 16
SHARP	06
SONY	07
THOMSON	26
TOSHIBA	08, 14
ZENITH	09

Manufacturers' codes are subject to change without notice. If they are changed, this remote control cannot operate the equipment.

Maintenance

To get the best performance of the unit, keep your discs and mechanism clean.

General Notes

In general, you will have the best performance by keeping your discs, and the mechanism clean.

- Store discs in their cases, and keep them in cabinets or on shelves.
- Keep the disc tray closed when not in use.

Handling Discs



- Remove the disc from its case by holding it at the edge while pressing the center hole lightly.
- Do not touch the shiny surface of the disc, or bend the disc.
- Put the disc back in its case after use to prevent warping.

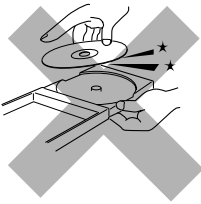

- Be careful not to scratch the surface of the disc when placing it back in its case.
- Avoid exposure to direct sunlight, temperature extremes, and moisture.



To clean the disc

Wipe the disc with a soft cloth in a straight line from center to edge.

DO NOT use any solvent—such as conventional record cleaner, spray, thinner, or benzine—to clean the disc.

Cleaning the unit

• Stains on the unit

Should be wiped off with a soft cloth. If the unit is heavily stained, wipe it with a cloth soaked in water-diluted neutral detergent and wrung well, then wipe clean with a dry cloth.

• Since the unit may deteriorate in quality, become damaged or get its paint peeled off, be careful about the following.

- DO NOT wipe it with a hard cloth.
- DO NOT wipe it strong.
- DO NOT wipe it with thinner or benzine.
- DO NOT apply any volatile substance such as insecticides to it.
- DO NOT allow any rubber or plastic to remain in contact with it for a long time.

Troubleshooting

Use this chart to help you solve daily operational problems. If there is any problem you cannot solve, contact your JVC service center.

PROBLEM	POSSIBLE CAUSE	SOLUTION
Power does not come on.	The power cord is not plugged in.	Insert the plug into the socket.
The remote control does not work.	<ul style="list-style-type: none"> • It is too far from the center unit, or is not facing the center unit. • There is something obstructing the remote sensor. • The CONTROL VCR or CONTROL TV button has been pressed. • The battery is flat. • The battery has been inserted the wrong way round (+/-). • Sunlight is falling directly on the detector. 	<ul style="list-style-type: none"> • Come close to the center unit. • Avoid any obstacles. • Press DVD, FM/AM or AUX to operate the system. (See page 58) • Replace the battery. • Insert the battery correctly. • Shade the remote control from direct sunlight.
No sound.	<ul style="list-style-type: none"> • There is a short in the speaker cord. • The audio cord is not connected properly. • An incorrect source has been selected. • Muting is on. • The disc is copy-protected CD. 	<ul style="list-style-type: none"> • Reconnect the speaker cord. • Connect the cord properly. (See page 8.) • Select the correct source. (See pages 10 to 16.) • Press MUTING to cancel muting. • Replace the disc.
Sound is emitted from only one speaker.	<ul style="list-style-type: none"> • The speaker cord is not connected correctly. 	<ul style="list-style-type: none"> • Connect the cord properly. (See page 7.)
No video.	<ul style="list-style-type: none"> • The video cord is not connected properly. • TV input selection is incorrect. 	<ul style="list-style-type: none"> • Connect the cord properly. (See page 9.) • Select the correct input.
A disc cannot be played.	<ul style="list-style-type: none"> • The system and disc region code numbers are incompatible. • The disc causes the parental (rating) error. 	<ul style="list-style-type: none"> • Replace the disc. (See page 22.) • Enter password to change the parental (rating) level. (See page 57.)
“Error” appears on the TV screen.	<ul style="list-style-type: none"> • The CD-R/RW is not recorded in the audio CD format, MP3 format, or JPEG format. 	<ul style="list-style-type: none"> • Replace the disc.
Video and audio are distorted.	<ul style="list-style-type: none"> • The disc is dirty. • A VCR is connected between the center unit and the TV. 	<ul style="list-style-type: none"> • Clean the disc. • Connect the center unit and TV directly.
The moving picture is noisy.	<ul style="list-style-type: none"> • “Pause/Still” mode may not be set appropriately for the current disc. 	<ul style="list-style-type: none"> • Select “Field” on “Pause/Still” mode. (See page 54.)
The edge is missing on the video image.	<ul style="list-style-type: none"> • Initial setup (Monitor Type) was incorrect. 	<ul style="list-style-type: none"> • Set Monitor Type correctly. (See page 54.)
Continuous static during FM broadcasts.	<ul style="list-style-type: none"> • The received signal is too weak. • The station is too far away. • The antenna is not connected correctly. 	<ul style="list-style-type: none"> • Connect an external FM antenna (see page 5), or contact your dealer. • Select another station. • Check the connection. (See page 5.)
The system does not work correctly.	<ul style="list-style-type: none"> • Lightning or electronic noise interferes with operation of the microcomputer. • Immediately after beginning to heat the room, the unit was moved to a cold location causing condensation to form inside. 	<ul style="list-style-type: none"> • Switch power off, and remove and re-insert the power plug in the socket. • Switch power off and leave the unit a few hours before switching power on again.
The VCR cannot be operated using this remote control.	<ul style="list-style-type: none"> • The remote control is not set for VCR operations. • The VCR is not a JVC’s product. 	<ul style="list-style-type: none"> • Press CONTROL VCR to operate the VCR. (See page 58.) • This remote control can operate a JVC’s VCR whose remote control code is set to A code.

Specifications

Center unit (XV-THA35)

Amplifier section

Front/Center/Rear:

45 watts per channel, min. RMS at 6 ohms as 1 kHz, with no more than 10 % total harmonic distortion.

Subwoofer:

100 watts, min. RMS at 10 ohms as 100 Hz, with no more than 10 % total harmonic distortion.

Audio section

Audio input sensitivity/Impedance (at 1 kHz)

Analog input:

AUX ("AUX IN"): 500 mV/47 k Ω

Digital input*:

DIGITAL IN (OPTICAL):

-21 dBm to -15 dBm (660 nm \pm 30 nm)

* Corresponding to Linear PCM, Dolby Digital, and DTS Digital Surround (with sampling frequency — 32 kHz, 44.1 kHz, 48 kHz)

Video section

Color System: PAL

Horizontal Resolution: 480 lines

Signal-to-Noise Ratio: 68 dB

Output Level

VIDEO(Composite): 1.0 V(p-p)/75 Ω

S-VIDEO(Y): 1.0 V(p-p)/75 Ω

(C): 0.286 V(p-p)/75 Ω

Tuner section

Tuning Range FM: 87.50 MHz – 108.00 MHz

AM(MW): 522 kHz – 1 629 kHz

General

Readable Discs: DVD VIDEO, Video CD, Super Video CD, Audio CD, CD-R/RW (Audio CD, Video CD, Super Video CD, MP3 disc, and JPEG disc), DVD-R (Video format)

Power Requirements: AC 230 V \sim , 50 Hz

Power Consumption: 180 W (at operation)
2 W (in standby mode)

Dimensions (W \times H \times D): 360 mm \times 65 mm \times 360 mm

Mass: 6.6 kg

Subwoofer (SP-WA35)

Speaker: 16 cm
Bass-reflex, Magnetically Shielded

Power Handling Capacity: 100 W

Impedance: 10 Ω (min)

Frequency Range: 25 Hz to 200 Hz

Dimensions (W \times H \times D): 202 mm \times 330 mm \times 341 mm

Mass: 4.8 kg

Satellite Speakers (SP-THA35F)

Speakers: 8 cm
Bass-reflex, Magnetically Shielded

Power Handling Capacity: 45 W

Impedance: 6 Ω (min)

Frequency Range: 90 Hz to 20 kHz

Dimensions (W \times H \times D): 92 mm \times 97.5 mm \times 92 mm

Mass: 650 g

Designs & specifications are subject to change without notice.

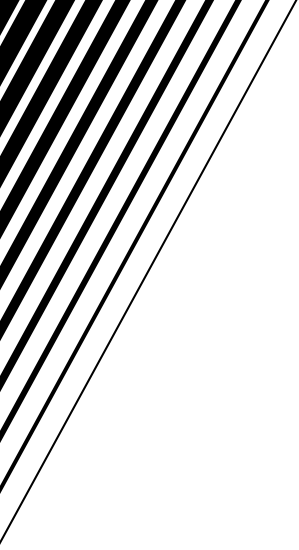

JVC
VICTOR COMPANY OF JAPAN, LIMITED